

VERDERGEAR

VGS 096, 230V

Description

Verdergear gear pumps are ideally suited for the precise and repeatable pumping of hazardous liquids or expensive chemicals. They operate pulsation-free and due to the magnetic coupling they are absolutely leakage-free.

This pump is equipped with a 230 V (1 phase) AC motor and has a frequency converter incl. potentiometer as well as an internally wired forced cooling fan. A speed range of 50-5000 rpm is adjustable.

The frequency inverter is configured via an integrated adjustment module with digital display.

Control is via potentiometer or interfaces such as 0-10 V, 4-20 mA or RS485. As an option, common interfaces such as Profi Bus, CANopen, EtherCAT, Mod Bus RTU or sercos are of course also available.

Your Benefits

- Very reliable, pulsation-free pumping
- High dosing accuracy
- Corrosion resistant materials
- Very service-friendly
- Large adjustment range
- No external frequency converter required
- One motor for different pump heads



Technical details

Max. flow	96 l/h @3000 rpm	Viscosity*	1-2000 cPs
Max. differential pressure	17 bar	Connections**	1/8" NPT
Max. system pressure	34 bar	Noise level	< 70 dB (A)
Speed	50-5.000 rpm	Temperature***	-46 to +176 °C

*Higher viscosities possible on request

**Optional 1/4" NPT

***Gear trim from 60 °C

Materials

Description	Material	Optional
O-ring	PTFE	Viton
Gears	PEEK	PPS
Casing	Stainless steel 316	Hastelloy, Titan



VERDERGEAR

VGS 096, 230V

Performance curve

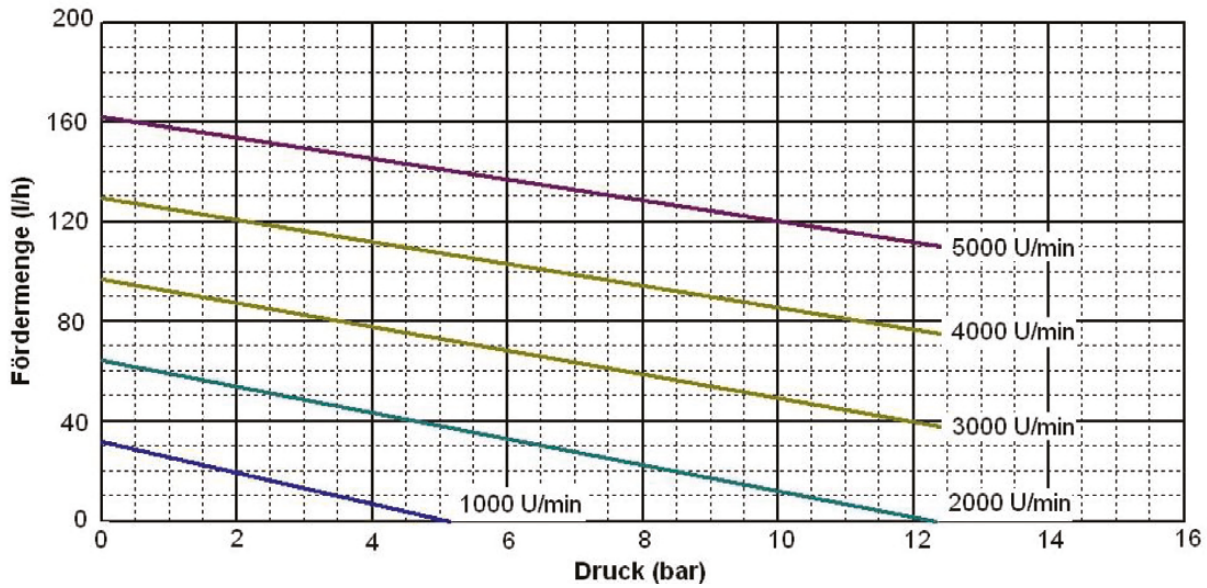

The performance curves shown apply to:
 1 bar suction pressure; 20 °C medium temperature; 1 cPs medium viscosity; by-pass valve completely closed.

Dimensions

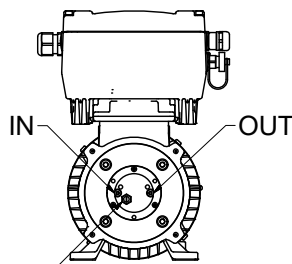
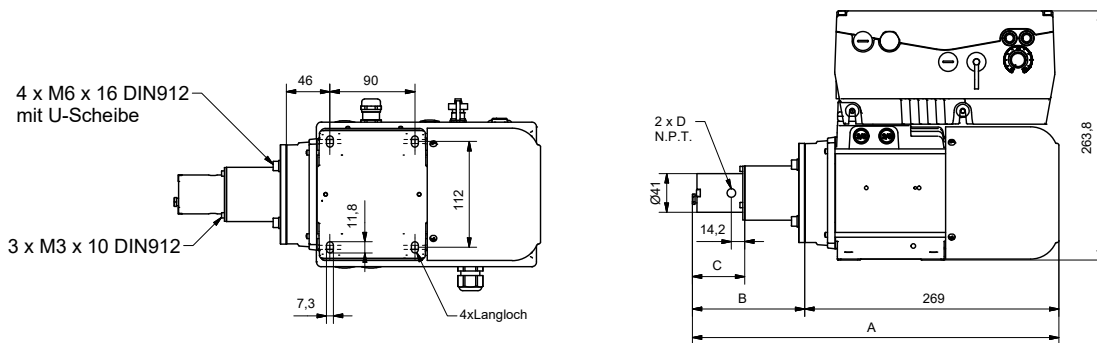

A	B	C	D
391,4 mm	122,4 mm	58,9 mm	1/8"

All dimensions in mm (dimensions are for guidance only)

Find your local supplier at
www.verderliquids.com

VERDER
 passion for pumps

