

Verderflex VF80

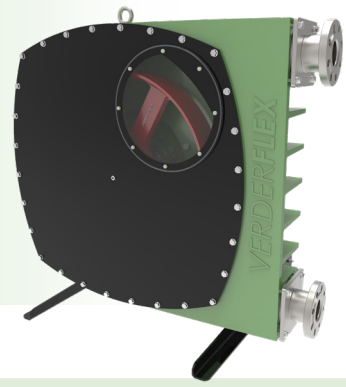

VERDERFLEX®

Description	Material	Paint Detail
Pump Housing	Cast Iron (GG25)	Green Powder Coated
Front Cover	Carbon Steel with Perspex Inspection Window	Powder Coated
Rotor	Cast Iron (GG25)	
Rotor Shoes	Aluminium (6082T6)	
Port Flange	304 Stainless Steel Universal slotted design fits with 80 mm 3" DIN PN16, ANSI 150# & JIS10K Tri-Clamp Port Flange Assembly DIN 32676 available on request	
Inserts	Stainless Steel (316L) Options: Polypropylene, P.V.D.F. Inserts	
Mounting Frame	Carbon Steel	Powder Coated
Lubricant	Verderlube - Glycerine based compound Verdersil - Silicone oil	
Hose	Natural Rubber (NR) Options: Nitrile Buna Rubber (NBR) Ethylene Propylene Diene Mono-mer (EPDM), Food Grade Nitrile Buna (NBRF) and Hypalon® (CSM)	
Typical Pump Unit Weight	1057 - 1074 kg	

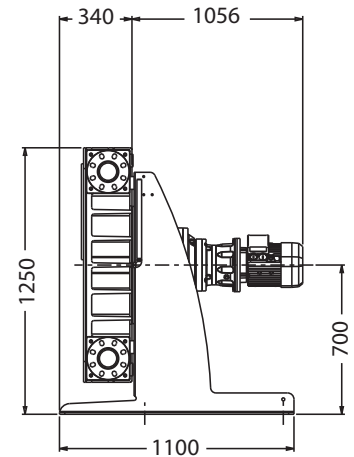
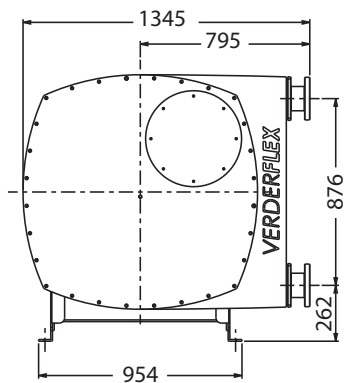
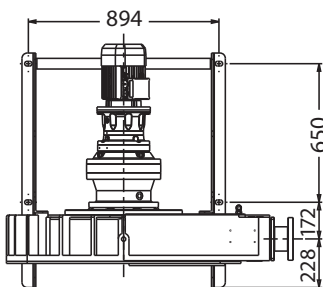

All dimensions are in mm.
All dimensions and weights are for guidance only.



Verderflex VF80

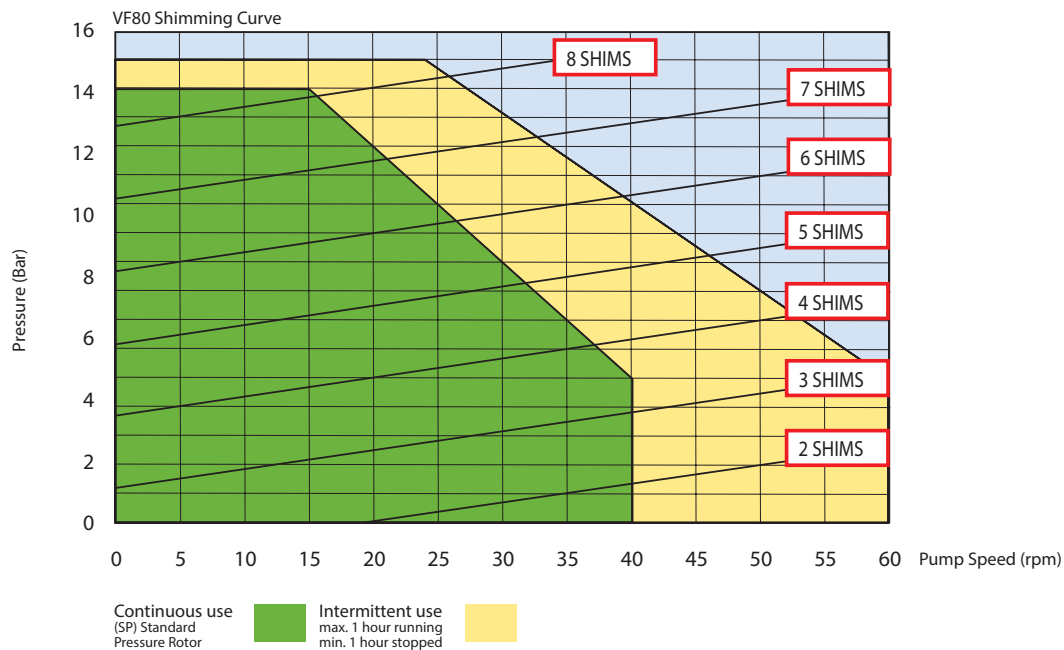
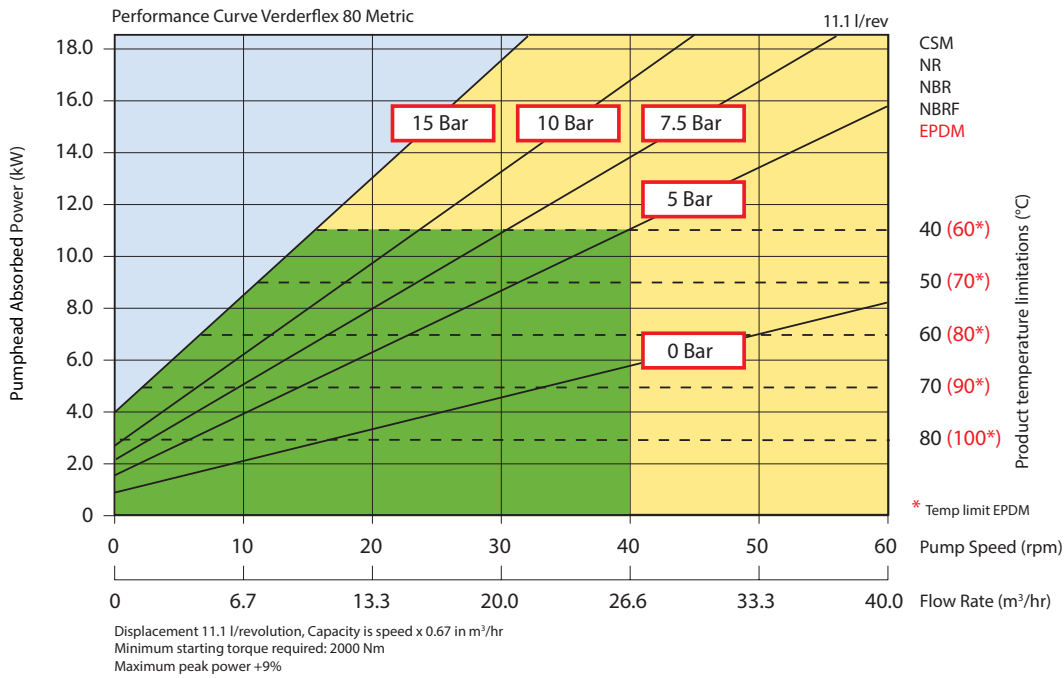
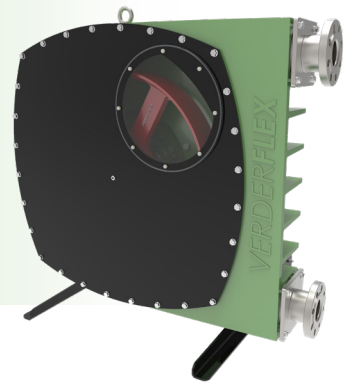

For product temperatures above 65°C and/or viscosity above 2000 mPas use one shim less than shown

Flows are typical and were measured with water at 20°C with no suction lift or discharge pressure. Actual flows will vary according to suction conditions, discharge pressure and normal component production tolerances.

VF_Techno_Rev04_2019_(eu)

Find your local supplier
at www.verderflex.com

For construction installation and floor mounting drawings
please contact your local authorised Verderflex® distributor.

VERDER
passion for pumps