

## Peristaltic Cased Tube Pumps

Operating Manual

Verderflex Economy

45, 500, 1500, 3000, 8000

Version 1.0v-01/2014  
Print No. 01





Version 1.0v-01/2014  
Print-No. 01

**Verderflex Economy**  
45, 500, 1500, 3000, 8000



**The information in this document is essential for the safe operation and servicing of Verderflex Economy pumps. This document must be read and understood thoroughly prior to installation of unit, electrical connection and commissioning.**

## Table of contents

### 1 About the product

- 1.1 Key features

### 2 Warranty

### 3 Pump returns

### 4 'EC' Declaration

### 5 Safety

- 5.1 Intended use
- 5.2 Prevention of obvious misuse

### 6 Operation

### 7 Pump head options and installation

- 7.1 Types of pump head
- 7.2 Economy EV 045
  - 7.2.1 Key features
  - 7.2.2 Controls
  - 7.2.3 Replacing tube assembly
  - 7.2.4 Pump specification – Tube / flow rate
  - 7.2.5 Mains supply
  - 7.2.6 Fuse rating
  - 7.2.7 Dimensions
  - 7.2.8 Motor
- 7.3 Economy EV 500
  - 7.3.1 Key features
  - 7.3.2 Controls
  - 7.3.3 Replacing tube assembly
  - 7.3.4 Pump specification – Tube / flow rate
  - 7.3.5 Mains supply
  - 7.3.6 Fuse rating
  - 7.3.7 Dimensions
  - 7.3.8 Motor
- 7.4 Economy EV 1500
  - 7.4.1 Key features
  - 7.4.2 Controls
  - 7.4.3 Tube replacement
  - 7.4.4 Pump specification – Tube / flow rate
  - 7.4.5 Mains supply
  - 7.4.6 Fuse rating
  - 7.4.7 Dimensions
  - 7.4.8 Motor

- 7.5 Economy EV 3000
  - 7.5.1 Key features
  - 7.5.2 Controls
  - 7.5.3 Replacing tube elements
  - 7.5.4 Changing rotor
  - 7.5.5 Pump specification – Tube / flow rate
  - 7.5.6 Mains supply
  - 7.5.7 Fuse rating
  - 7.5.8 Dimensions
  - 7.5.9 Motor

- 7.6 Economy EV 8000
  - 7.6.1 Key features
  - 7.6.2 Controls
  - 7.6.3 Replacing tube elements
  - 7.6.4 Changing rotor
  - 7.6.5 Operation
  - 7.6.6 Pump specification – Tube / flow rate
  - 7.6.7 Mains supply
  - 7.6.8 Dimensions
  - 7.6.9 Fuse rating
  - 7.6.10 Motor

### 8 Maintenance

- 8.1 Fuse replacement

### 9 Declaration of conformity according to EC Machine Directive

# 1 About the product

 The Verderflex Economy range of peristaltic tube pumps are a simple to use, 'no frills' range of cased drive tube pumps. Ideal for bench-top use in laboratories and process environments, this compact range provides accurate flow and consistent dosing up to 8,000 ml/min (127 US GPH)

## 1.1 Key features

- Flow rates from a few ml/min up to 8,000 ml/min (127 US GPH)
- Fast Prime switch
- Variable speed control
- IP30 Chemical resistant Epoxy polyester coating
- Gentle pumping action, ideal for shear sensitive fluids
- Highly accurate dosing with no product slip
- Zero contamination - the fluid is hygienically contained within the tubing of the pump
- Self priming
- Dry running
- Reversible
- Ideal for dosing harsh, aggressive, or viscous products
- Quick and easy tube change.

# 2 Warranty

 The manufacturer does not accept any liability for damage resulting from disregard of this documentation.

This product is guaranteed to be free from defects in material or workmanship for a period of 24 months from date of purchase, excluding consumable items such as cartridges, tubing or rollers. Products out of guarantee period will be repaired for a nominal charge.

# 3 Pump returns

 All returned pumps must be decontaminated before being returned. The Decontamination Certificate should be separately requested and must be returned before or with the pump delivery. For your protection, items returned must be carefully packed to prevent damage in transit and insured against loss.

# 4 'EC' Declaration

 The Verderflex Economy range, complies with EMC 2004/ 108/ EC as well as Machine Directive 2006/42/EC.

Installation of this pump into other equipment must be in accordance with relevant Directives/Standards and be carried out by a suitably competent person.

# 5 Safety

 The manufacturer does not accept any liability for damage resulting from disregard of this documentation.

## 5.1 Intended use

- Only use the pump to handle compatible fluids as recommended by the manufacturer.
- Adhere to the operating limits.
- Consult the manufacturer regarding any other use of the pump.

## 5.2 Prevention of obvious misuse

- Note the operating limits of the pump with regard to temperature, pressure, flow rate and motor speed.
- Do not operate the pump while the inlet/outlet valve is closed.
- Only install the pump as recommended in this manual. For example, the following are not allowed:
  - Installing the pump without proper support.
  - Installation in the immediate vicinity of extreme hot or cold sources.
- Do not use in conjunction with life support equipment
- Do not connect pump to the human body

 **DANGER**

### Risk of electrocution!

- ▶ Make sure that the electrical information on the rating plate agrees with the power supply.
- ▶ Isolate the main supply before replacing the tube/cartridge
- ▶ Isolate the main supply before removing the enclosure cover

# 6 Operation

 Check voltage selector on Rear Panel indicates correct voltage. Connect mains supply and turn 'ON' mains switch. Mains neon indicator will illuminate on Front Panel.

The unit can be operated using the Front Panel mounted Control Switch. This three-position switch gives clockwise and anti-clockwise rotation with a central 'OFF' position. Pump speed can be varied using the Speed Control potentiometer mounted on the Front Panel.

The fast prime switch will over ride the speed setting for initial priming on all models except EV 8000.

# 7 Pump head options and Installation

 Pump should be installed by suitably qualified personnel

- Pump should be sited on stable horizontal surface
- Allow free flow of air around pump
- Tube should not be allowed to kink.

## 7.1 Types of pump head

 Verderflex® Economy pumps are available in five different models, each with a different head also featured on the Verderflex OEM range.



		
<p>1. EV 045</p>	<p>2. EV 500</p>	<p>3. EV 1500</p>
		
<p>4. EV 3000</p>	<p>5. EV 8000</p>	

Table 1 Economy Pump heads

## 7.2 Economy EV 045

### 7.2.1 Key features

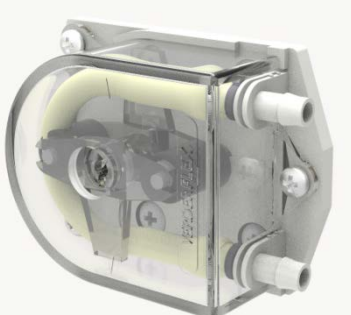
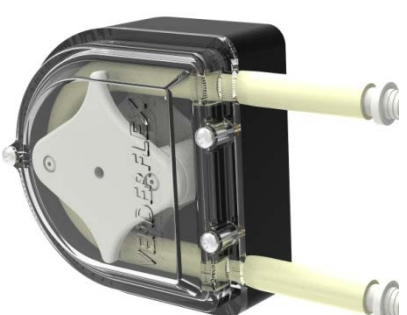
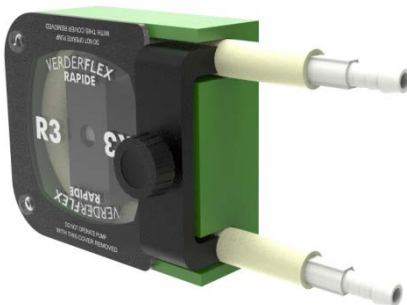
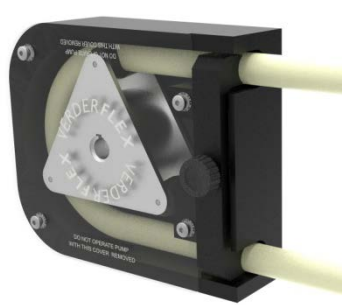
 Low flow pump with easy-change tube assemblies

1. Flow rates up to 60 ml/min (0.95 US GPH)
2. Pressures up to 2 Bar (29 PSI)
3. Typically used in frequent tube change applications
4. 2 roller design with optional 3 roller upon request
5. DC brushed motor

### 7.2.2 Controls

1. Direction switch
2. Manually controlled with potentiometer
3. Fast prime push button
4. Rotary speed control

### 7.2.3 Replacing tube assembly

 Fitting or changing the tube assembly is a quick and simple operation

1. Switch 'OFF' supply and remove pump cover to reveal tube.
2. Remove tube.
3. When replacing tube take care not to trap tube against rotor.
4. Refit cover.

### 7.2.4 Pump specification – Tube / Flow rate

Tube size	Material	Flow rate
1.6 x 1.6 mm	Verderprene/Silicone	0.7 – 12 ml/min
3.2 x 1.6 mm	Verderprene/Silicone	03 – 36 ml/min
4.0 x 1.6 mm	Silicon	05 – 60 ml/min

Table 2 Tube / flow rate

\* Flows are typical and were measured with water at 20°C with no suction lift or discharge pressure.

Actual flows will vary according to suction conditions, discharge pressure, tube material and production tolerances.

### 7.2.5 Mains supply

Voltage	Frequency	Power
230	50/60 hz	8W
110	50/60 hz	8W

Table 3 Mains supply

\*(Units are factory set to operate at voltage stated on rear identity label)



Fig.1 Verderflex Economy EV 045

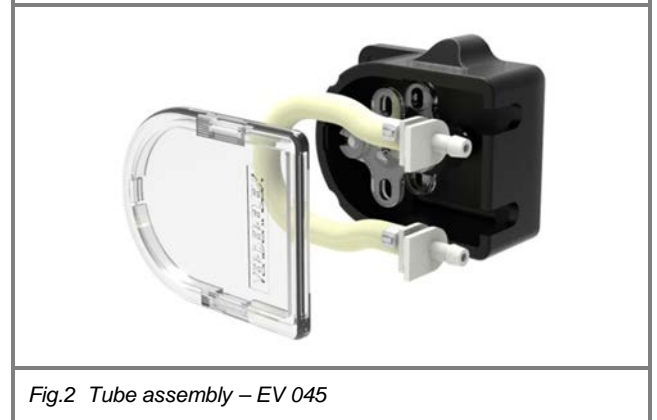

Fig.2 Tube assembly – EV 045

### 7.2.6 Fuse rating

Fuse	230 V	110 V
FS1	250mA	500mA
FS2	250mA	500mA

Table 4 Fuse rating

\*(Fuses are 20mmx5mm anti surge glass cartridges to BS4265 or IEC127)

### 7.2.7 Dimensions

Length	Width	Height	Weight
185mm	204mm	109mm	1.7kg

Table 5 Dimensions

### 7.2.8 Motor

 12V d.c, 5 - 60rpm Permanent magnet

## 7.3 Economy EV 500

### 7.3.1 Key features

 Popular low flow cased tube pump with polycarbonate pump head housing.

1. Flow rates up to 185 ml/min (2.93 US GPH)
2. Pressures up to 2 Bar (29 PSI)
3. Polycarbonate pump head housing
4. 2 roller design with optional 3 roller upon request
5. DC brushed motor

### 7.3.2 Controls

1. Direction switch
2. Manually controlled with potentiometer
3. Fast prime push button
4. Rotary speed control

### 7.3.3 Replacing tube assembly

 Fitting or changing the tube assembly is a quick and simple operation

1. Switch 'OFF' supply and remove pump housing to reveal tube.
2. Remove tube assembly.
3. When replacing tube assembly take care not to trap tube against rotor.
4. Refit cover.

### 7.3.4 Pump specification – Tube / Flow rate

Tube size	Material	Flow rate
1.6 x 1.6 mm	Verderprene/Silicone	02 – 23 ml/min
3.2 x 1.6 mm	Verderprene/Silicone	05 – 82 ml/min
4.8 x 1.6 mm	Silicon	11 – 185 ml/min

Table 6 Tube / flow rate

\* Flows are typical and were measured with water at 20°C with no suction lift or discharge pressure.

Actual flows will vary according to suction conditions, discharge pressure, tube material and production tolerances.

### 7.3.5 Mains supply

Voltage	Frequency	Power
230	50/60 hz	20W
110	50/60 hz	20W

Table 7 Mains supply

\*(Units are factory set to operate at voltage stated on rear identity label)



Fig.3 Verderflex Economy EV 500



Fig.4 Tube assembly – EV500

### 7.3.6 Fuse rating

Fuse	230 V	110 V
FS1	250mA	1 A
FS2	250mA	1 A

Table 8 Fuse rating

\*(Fuses are 20mmx5mm anti surge glass cartridges to BS4265 or IEC127)

### 7.3.7 Dimensions

Length	Width	Height	Weight
185mm	204mm	109mm	1.7kg

Table 9 Dimensions

### 7.3.8 Motor

 24V d.c, 5 - 82 rpm Permanent magnet



## 7.4 Economy EV 1500

### 7.4.1 Key features

 Higher flow pump with easy-change tube assemblies

1. Flow rates up to 2570 ml/min (40.73 US GPH)
2. Pressures up to 2 Bar (29 PSI)
3. 2 Roller nylon rotor
4. Robust design
5. DC brushed motor

### 7.4.2 Controls

1. Direction switch
2. Manually controlled with potentiometer
3. Fast prime push button
4. Rotary speed control

### 7.4.3 Tube replacement

 Fitting or changing the tube is a quick and simple operation

1. Switch 'OFF' supply and remove pump cover to reveal tube.
2. Remove tube.
3. When replacing tube take care not to trap tube against rotor.
4. Refit cover.

### 7.4.4 Pump specification – Tube / Flow rate

Tube size	Material	Flow rate
6.4 x 2.4	Verderprene/Silicone	190 – 1710 ml/min
8.0 x 2.4	Verderprene/Silicone	280 – 2570 ml/min

Table 10 Tube / flow rate

\* Flows are typical and were measured with water at 20°C with no suction lift or discharge pressure.

Actual flows will vary according to suction conditions, discharge pressure, tube material and production tolerances.

### 7.4.5 Mains supply

Voltage	Frequency	Power
230	50/60 hz	180W
110	50/60 hz	180W

Table 11 Mains supply

\*(Units are factory set to operate at voltage stated on rear identity label)

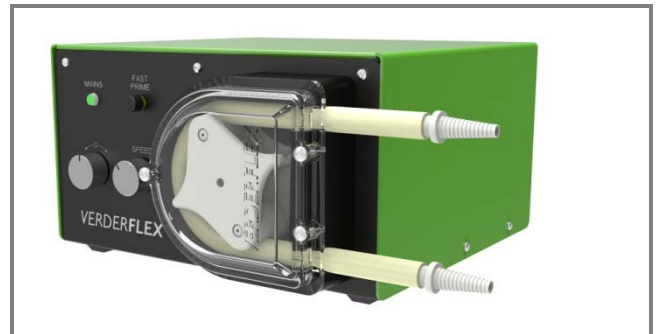

Fig.5 Verderflex Economy EV1 500



Fig.6 Tube assembly – EV 1500

### 7.4.6 Fuse rating

Fuse	230 V	110 V
FS1	1 A A/S	2 A A/S
FS2	1 A A/S	2 A A/S
FS3	5 A A/S	5 A A/S

Table 12 Fuse rating

\*(Fuses are 20mmx5mm anti surge glass cartridges to BS4265 or IEC127)

### 7.4.7 Dimensions

Length	Width	Height	Weight
274mm	245mm	139mm	3.0 kg

Table 13 Dimensions

### 7.4.8 Motor

 24V d.c, 30 - 240 rpm Permanent magnet



## 7.5 Economy EV 3000

### 7.5.1 Key features

 Robust pump with thick wall tubing for viscous products with higher flow rates.

1. Flow rates up to 3850 ml/min (61.02 US GPH)
2. Pressures up to 2 Bar (29 PSI)
3. 2 roller design
4. DC brushed motor

### 7.5.2 Controls

1. Direction switch
2. Manually controlled with potentiometer
3. Fast prime push button
4. Rotary speed control

### 7.5.3 Replacing tube elements

1. Remove the clamp, but leave the front cover in place
2. Run the pump at low speed and carefully feed tube through the inlet
3. When tube reach outlet, use blunt end rod to guide the tube out.
4. Fit tube clamp loosely, and position tube with marked lines adjacent to edge of pump housing and tube clamp.
5. Tighten the tube clamp securely

### 7.5.4 Changing rotor

1. Align grub screw hole with flat on shaft
2. Align peak of roller with peak of tube track or set rotor distance back from front of pump housing as indicated (Refer Figure 9)
3. Fasten grub screw securely

### 7.5.5 Pump specification – Tube / Flow rate

Tube size	Material	Flow rate
6.4 x 3.2	Verderprene/Silicone	210 – 1925 ml/min
8.0 x 3.2	Verderprene/Silicone	330 – 3025 ml/min
9.6 x 3.2	Verderprene/Silicone	420 – 3850 ml/min

Table 14 Tube / flow rate

\* Flows are typical and were measured with water at 20°C with no suction lift or discharge pressure.

Actual flows will vary according to suction conditions, discharge pressure, tube material and production tolerances.

### 7.5.6 Mains supply

Voltage	Frequency	Power
230	50/60 hz	180W
110	50/60 hz	180W

Table 15 Mains supply

\*(Units are factory set to operate at voltage stated on rear identity label)



Fig.7 Verderflex Economy EV 3000

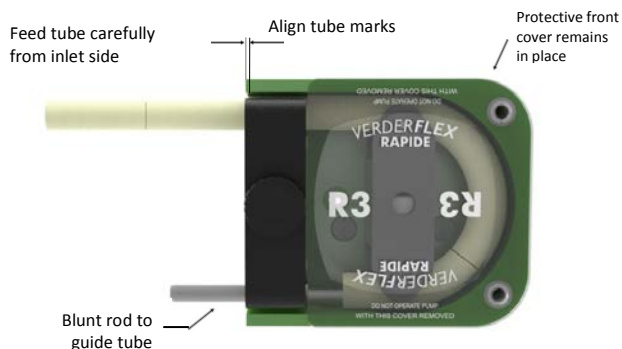

Fig.8 Tube assembly – EV 3000

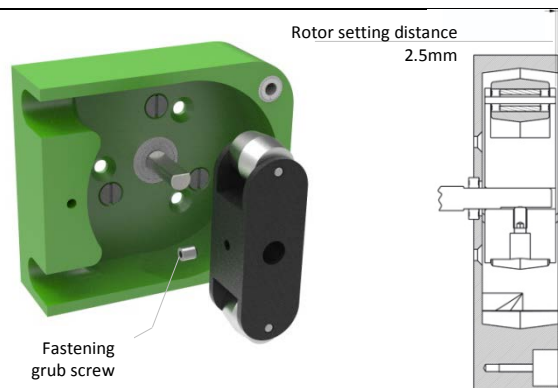

Fig.9 Replacing the rotor – EV 3000

### 7.5.7 Fuse Rating

Fuse	230 V	110 V
FS1	1 A A/S	2 A A/S
FS2	1 A A/S	2 A A/S
FS3	5 A A/S	5 A A/S

Table 16 Fuse rating

\*(Fuses are 20mmx5mm anti surge glass cartridges to BS4265 or IEC127)

### 7.5.8 Dimensions

Length	Width	Height	Weight
274mm	245mm	139mm	3.0 kg

Table 17 Dimensions

### 7.5.9 Motor

 24V d.c, 30 - 250 rpm Permanent magnet

## 7.6 Economy EV 8000

### 7.6.1 Key features

 Higer flow pump with easy-change tube assemblies

1. Flow rates up to 8000 ml/min (126.80 US GPH)
2. Pressures up to 2 Bar (29 PSI)
3. 3 Roller aluminium alloy rotor
4. Robust brushed d.c. motor

### 7.6.2 Controls

1. Direction flip switch
2. Manual speed control

### 7.6.3 Replacing tube elements

1. Remove the clamp, but leave the front cover in place
2. Run the pump at low speed and carefully feed tube through the inlet
3. When tube reach outlet,use blunt end rod to guide the tube out.
4. Fit tube clamp loosely, and position tube with marked lines adjacent to edge of pump housing and tube clamp.
5. Tighten the tube clamp securely

### 7.6.4 Changing rotor

1. Align grub screw hole with flat on shaft
2. Align peak of roller with peak of tube track or set rotor distance back from front of pump housing as indicated (*Refer Figure 12*)
3. Fasten grub screw securely

### 7.6.5 Operation

 The unit can be operated using the Front Panel mounted Control Switch. This three-position switch gives clockwise and anti-clockwise rotation with a central 'OFF' position. Pump speed can be varied using the Speed Control potentiometer mounted on the Front Panel. '00' to '99' on the digital potentiometer represents speed range of 0 – 180 RPM.

### 7.6.6 Pump specification – Tube / Flow rate

Tube size	Material	Flow rate
12.7 x 3.2	Verderprene/Silicone	0 – 8000 ml/min

Table 18 Tube / flow rate

\* Flows are typical and were measured with water at 20°C with no suction lift or discharge pressure.

Actual flows will vary according to suction conditions, discharge pressure, tube material and production tolerances.

### 7.6.7 Mains supply

Voltage	Frequency	Power
230	50/60 hz	150W
110	50/60 hz	150W

Table 19 Mains supply

\*(Units are factory set to operate at voltage stated on rear identity label)

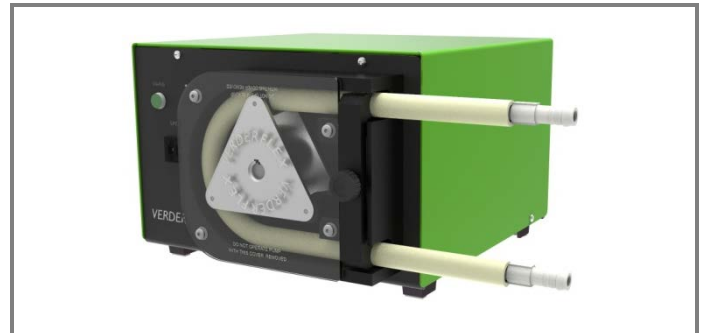

Fig. 10 Verderflex Economy EV 8000

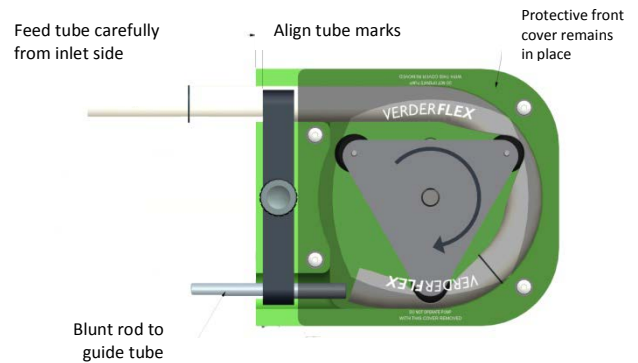

Fig. 11 Tube assembly – EV 8000

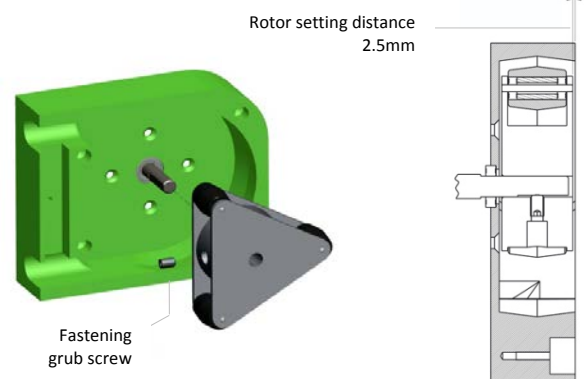

Fig. 12 Replacing the rotor – EV 8000

### 7.6.8 Dimensions

Length	Width	Height	Weight
373mm	313mm	213mm	8.0 kg

Table 20 Dimensions

### 7.6.9 Fuse rating

Fuse	230 V	110 V
FS1	2 A A/S	3.15 A A/S
FS2	2 A A/S	3.15 A A/S
FS3	5 A A/S	5 A A/S

Table 21 Fuse rating

\*(Fuses are 20mmx5mm anti surge glass cartridges to BS4265 or IEC127)

### 7.6.10 Motor

 130V d.c, 0 - 180 rpm Permanent magnet

## 8 Maintenance

 Motor and Gearbox are lubricated for life and should not require attention. Rotor rollers are self-lubricated. Pump tubing will not last forever; establish suitable tube replacement schedule to prevent inconvenient tube failure

This pump contains no user serviceable parts and is factory sealed to confirm integrity. Pump warranty will be invalidated if the seal is broken.



Figure 13 Tamper proof label

### 8.1 Fuse Replacement

The Mains inlet is located on the Rear Panel incorporating twin mains fuses FS1 and FS2. Under normal operating conditions these fuses should not require replacement.

In the event of fuse failure a replacement should be fitted, its value is stated in the specification. Qualified personnel should investigate repeated fuse failure.

U.K. only - The mains lead supplied with U.K. models incorporates a 3 pin 13 amp plug fitted with a 5-amp fuse.

## 9 Declaration of conformity according to EC Machine Directive

<p><b>EC declaration of conformity according to machine directive, appendix II A</b></p> <p>We,                  VERDER Ltd., Unit 3 California Drive, Castleford                  hereby declare that the following machine adheres to the relevant EC directives detailed below</p>		
<p>Designation</p>	<p><b>Verderflex Economy EV 045</b>  <b>Verderflex Economy EV 500</b>  <b>Verderflex Economy EV 1500</b>  <b>Verderflex Economy EV 3000</b>  <b>Verderflex Economy EV 8000</b></p>	
<p>EC directives:</p> <ul style="list-style-type: none"> <li>• Machine Directive (2006/42/EC)</li> <li>• Low-voltage directive (2006/95/EC)</li> <li>• EMC directive (2004/108/EC)</li> </ul>		
<p>Applicable harmonized norms:</p> <ul style="list-style-type: none"> <li>• EN ISO 12100: 2010</li> </ul>		
<p>Responsible for the documentation</p>	<p>VERDER Ltd.                  Unit 3 California Drive                  Castleford                  WF10 5QH                  UK</p>	
<p>Date: 01/ 01/ 2014</p>	<p>Company stamp / signature:</p>  <p>David Sampson                  Head of Development/Construction</p>	<p>Company stamp / signature:</p>  <p>David Hoyland                  Head of Quality</p>

**Table 22: Declaration of conformity according to EC Machine Directive**

