

CHARACTERISTICS

	STANDARD	AVAILABLE OPTIONS	
Technology	Vane pump		
Maximum Flow rate at 1 cst (m ³ /h / GPM)	15 / 66		
Cubic capacity (l / cu.in)	0.29 / 17.7		
Internal relief valve	Single	Double, no relief valve	
Rotation	Reversible		
Ports	ISO PN16 Flanges		
Heating	-	Heating jacket	
Dimensions (mm / in.)	A	101 / 3.98	
	B	316 / 12.44	
	C	62.5 / 2.46	
	D	125 / 4.93	
	E	112 / 4.41	
	F	323 / 12.72	396 / 15.6 with double relief valve
	G	327 / 12.87	281.5 / 11.09 without relief valve.
	H	250 / 9.84	
Weight (kg / lbs)	41 / 90.4	38 / 84 without relief valve	

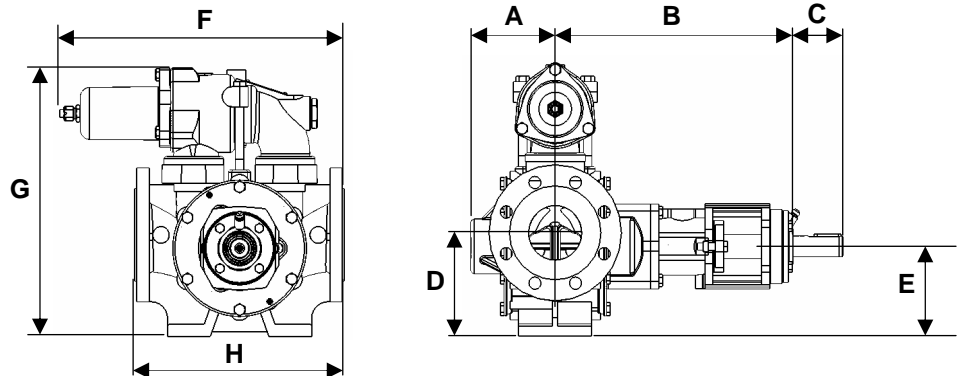

OPERATING LIMITS

	STANDARD MATERIALS	AVAILABLE OPTIONS
Minimum temperature °C / °F	-10 / 14	
Maximum temperature °C / °F	200 / 392	250 / 482 with FKM HT O rings
Maximum viscosity (cst / SSU)	200000 / 960000	
Maximum differential pressure (bar / psi)	13 / 188	
Maximum inlet pressure (bar g/psig)	1 / 14.5	
Maximum speed (rpm)	1000	

MATERIALS OF CONSTRUCTION

Part No	PART NAME	STANDARD MATERIALS	AVAILABLE OPTIONS
101	Casing	Stainless steel 316L	
301	Rotor	Stainless steel 316L	
317	Vanes	PEEK	
318	Push Rods	-	Stainless steel 304L
401	Cover	Stainless steel 316L	
407	Bushings	Carbon	
501	Shaft	Stainless steel 630	
508	Shaft end key	Stainless steel 316L	
536	Rotor key	Stainless steel 316L	
712	End Cover	Stainless steel 316L	
725	Outboard bearing holder	Stainless steel 316L	
705	Outboard bearing cover	Stainless steel 316L	
801	Relief valve casing	Stainless steel 316L	
823	Relief valve plug	Stainless steel 316L	
827	Relief valve cover	Stainless steel 316L	
	Bolts	Stainless steel 316	
	O rings	FKM	PTFE coated FKM, FKM HT
600	Mechanical seal (1)	Carbon/FKM/Silicon carbide/FKM	Carbon/PTFE/Silicon carbide/PTFE Sil. Carb./FKM/Silicon carbide/FKM Sil. Carb./PTFE/Silicon carbide/PTFE PTFE Packing Graphite Packing Flushed single seal (2) Flushed double seal (2)

- (1) Standardized mechanical seal only
(2) Consult factory

