

CHARACTERISTICS

	STANDARD	AVAILABLE OPTIONS
Technology	Eccentric Disc Mouvex®	
Maximum Flow rate at 1 cSt L/h (GPM)	12000 (52.83)	
Cubic capacity L (cu.in)	0,411 (25.08)	
Inlet chamber volume L (cu.in)	5.9 (360)	
Outlet chamber volume L (cu.in)	4.2 (256)	
Ports	DN 65 ISO PN16 flanges	ISO PN20 flanges SMS 1145 DIN 11851 DIN 11864 BF-A Aseptik fl. BS4825-5 CONNECT-S® CLAMP (ISO 2858) CHERRY BURREL IDF (ISO 2853)
Pump heating	None	Heating jacket
Dimensions mm (in.) (With ISO PN16 flanges)	A	768 (30.23)
	B	273 (10.75)
	C	438 (17.25)
	D	397.5 (15.65)
	E	343.5 (13.52)
	F	572 (22.52)
Weight kg (lbs)	119 (263)	

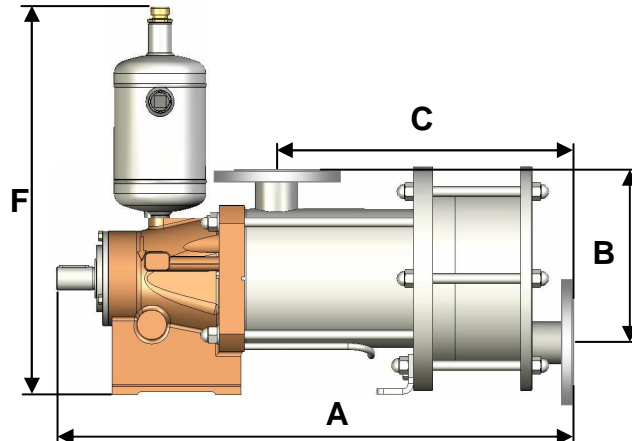
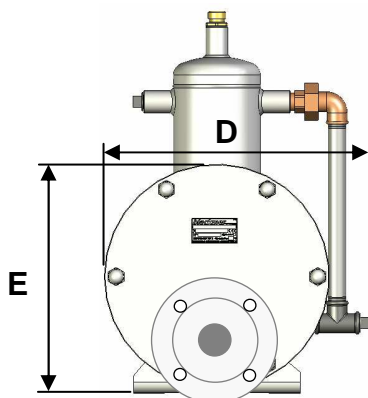

OPERATING LIMITS

	STANDARD MATERIALS
Minimum temperature °C (°F)	-15 (5)
Maximum temperature °C (°F)	160 (320)
Maximum viscosity cSt (SSU)	3000 (14000)
Maximum differential pressure bar (psi)	9 (130)
Maximum inlet pressure barg (psig)	1 (14.5)
Maximum speed rpm	530
Maximum solid particle size mm (in)	2 (0.079)
Maximum soft particle size mm (in)	10 (0.394)

MATERIALS OF CONSTRUCTION

Part No	PART NAME	STANDARD MATERIALS	AVAILABLE OPTIONS
101	Inlet Tube	316L Stainless Steel (low carbon)	
104	Inlet tube Bracket	316L Stainless Steel (low carbon)	
201	Cylinder	316L Stainless Steel (low carbon)	
301	Disc	CY5SnBiM (anti galling alloy)	
304	Disc Nut	316Ti Stainless Steel (Titanium Alloy)	
401	Outlet Cover	316L Stainless Steel (low carbon)	
402	Spacer tube	316L Stainless Steel (low carbon)	
	Bolts	316L Stainless Steel (low carbon)	
596	Transmission Assembly		
	Bearings	Ball / Roller / Needle	
	Double Bellows Assembly	316Ti & 316 L Stainless Fabrication	
	Housing	Cast iron	
	Screws	Steel	
	Transmission Lubricant	Synthetic oil	
	Seal Rings	Fluorocarbon (FKM) O-Rings	L - FKM gaskets PTFE Encapsulated O-rings

