

Company certified by

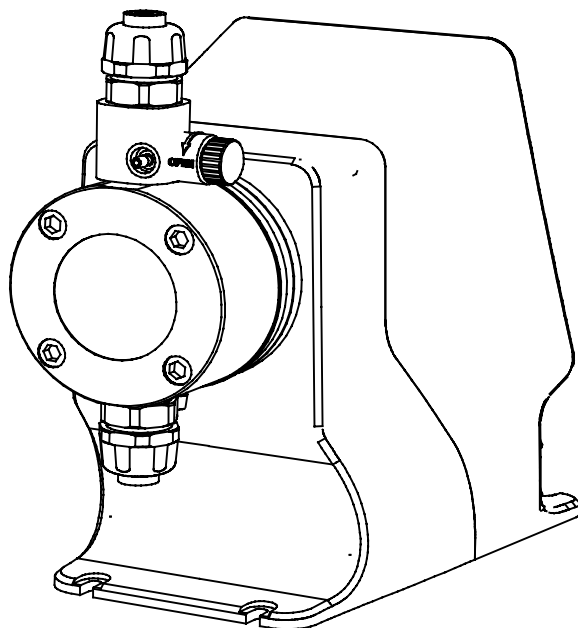

ITC 
DOSING PUMPS



DO SMART 

ENGLISH

CONTENTS

| | |
|------------------------------------|----|
| 1 GENERAL DESCRIPTION | 4 |
| 2 PACKING AND STORAGE | 5 |
| 3 TECHNICAL SPECIFICATIONS | 6 |
| FLOW AND PRESSURE GRAPHS | 8 |
| 4 INSTALLATION | 9 |
| 4.1 GENERAL | 9 |
| 4.2 WIRING | 10 |
| 4.3 HYDRAULIC INSTALLATION | 12 |
| 4.3.1 Installation examples | 12 |
| 4.3.2 Installation recommendations | 13 |
| 4.4 ACCESSORIES | 14 |
| 4.4.1 Diaphragm leakage detector | 14 |
| 4.4.2 Pressure sensor | 14 |
| 4.4.3 Pulse output isolator | 14 |
| 5 OPERATION | 15 |
| 5.1 OPERATING MODES | 17 |
| 5.1.1 Manual mode | 17 |
| 5.1.2 Proportional mode | 17 |
| 5.1.3 Analogue mode | 19 |
| 5.1.4 Batch dosing mode | 20 |
| 5.1.5 Special functions | 23 |
| 5.2 CONFIGURATION | 24 |
| 5.2.1 Pump calibration | 24 |
| 5.2.2 Dosing mode | 24 |
| 5.2.3 Configuration | 26 |
| 5.2.4 Inputs/outputs | 30 |

| | |
|--|----|
| 5.3 ALARMS | 32 |
| 5.3.1 Level alarm 1 | 32 |
| 5.3.2 Level alarm 2 | 32 |
| 5.3.3 Flow fault alarm | 33 |
| 5.3.4 Diaphragm leakage alarm | 34 |
| 5.3.5 Overpressure alarm | 34 |
| 5.4 MONITOR | 35 |
| 5.4.1 Real time | 35 |
| 5.4.2 Counters | 35 |
| 5.4.3 Info Unit | 36 |
| 6 START-UP AND REGULATION | 37 |
| 7 MAINTENANCE | 38 |
| Spare parts | 38 |
| Periodic Maintenance: | 42 |
| Troubleshooting: Possible cause and solution | 43 |
| Wiring | 45 |
| CE DECLARATION OF CONFORMITY | 47 |
| WARRANTY | 47 |



SAFETY INSTRUCTIONS

To avoid personal injury risks and damage to the environment, and to ensure proper equipment operation, personnel responsible for installing, commissioning and maintaining the equipment must follow the instructions in this manual, with special attention to the detailed recommendations and warnings. The specific instructions for the use of the chemicals to be dosed must also be followed.

This appliance must not be used by people (including children) with reduced physical, sensory or mental abilities or who lack experience and knowledge, unless they have received supervision or instruction. Children should not play with the appliance unsupervised.

1 GENERAL DESCRIPTION

DOSmart AC is a series of dosing pumps with a step motor and advanced control functions to automate precisely and efficiently the dosing of chemicals in liquid state.

This series of pumps is characterized by high precision, extensive regulation (1:3000) and high suction capacity even with viscous products. The flow range covers needs from 1.5 to 60 l/h at a pressure of up to 16 bar. The choice of the correct head material between PP, PVDF and stainless steel allows the dosing of any commonly used chemical in the water treatment, chemical, food and agriculture industries.

Operating modes

Manual: manual adjustment by keyboard of the flow rate to be dosed.

Analogue: dosing proportional to a 0/4 - 20 mA analogue signal.

Proportional to flow rate: dosing proportional to a water flow rate.

Proportional by pulses: stroke frequency, proportional to input pulses.

Batch control by volume: dosing a given volume. Manual, remote or timed activation.

Batch control by time: dosing for a given time. Manual, remote or timed activation.

ModBus: Dosing control via ModBus RTU protocol.

Code formulation

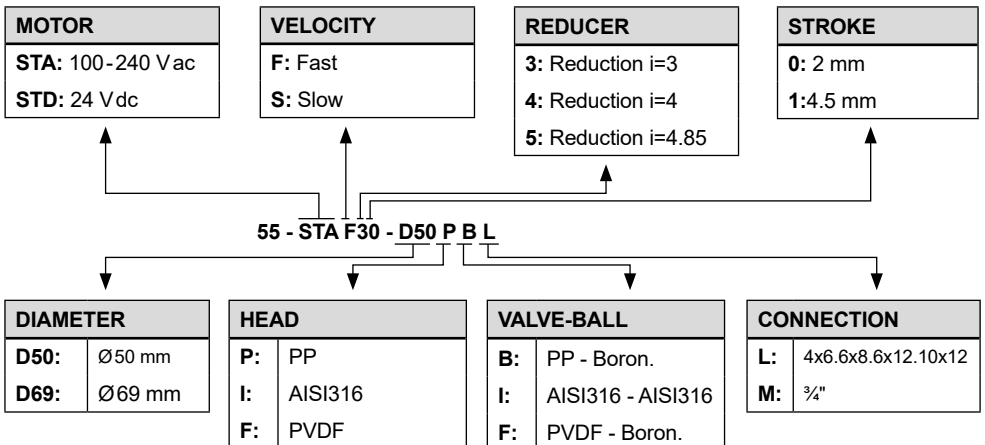

2 PACKING AND STORAGE

The original packaging is designed to allow the equipment to be transported and stored without damage, provided this takes place in dry, ventilated spaces away from heat sources.

Included in the packaging are:

- DOSmart AC dosing pump
- Instruction manual
- Connection accessories for 4x6, 6x8, 6x12, 10x12 conduit

3 TECHNICAL SPECIFICATIONS

| 55-STA... / 55-STD ... | | S50-D50 | F50-D50 | F30-D50 | F50-D69 | F30-D69 | F41-D69 | F31-D69 |
|---|-------|--|---------|----------|----------|---------|---------|---------|
| Flow max. at P max. | l/h | 1.5 | 4 | 8 | 12 | 24 | 40 | 60 |
| | gph | 0.40 | 1.05 | 2.10 | 3.15 | 6.30 | 10.50 | 15.80 |
| Max. pressure | Bar | 16 | 12 | 8 | 7 | 5 | 3 | 2 |
| | psi | 232 | 174 | 116 | 100 | 72 | 44 | 29 |
| Diaphragm diameter | mm | 50 | 50 | 50 | 69 | 69 | 69 | 69 |
| Stroke | mm | 2 | 2 | 2 | 2 | 2 | 4.5 | 4.5 |
| Cycles/min | | 40 | 82 | 143 | 85 | 164 | 113 | 164 |
| Volume/cycle at Pmax | ml | 0.63 | 0.82 | 0.93 | 2.36 | 2.44 | 5.92 | 6.08 |
| Adjustment range | | 1:3000 | 1:3000 | 1:3000 | 1:3000 | 1:3000 | 1:3000 | 1:3000 |
| Minimum flow | ml/h | 0.50 | 1.34 | 2.66 | 4.00 | 8.00 | 13.33 | 20.00 |
| | gpd | 0.0032 | 0.0085 | 0.0169 | 0.0254 | 0.0507 | 0.0845 | 0.1268 |
| Slow suction max. flow 75% | l/h | 1.12 | 3 | 6 | 9 | 18 | 30 | 45 |
| | gph | 0.30 | 0.79 | 1.59 | 2.36 | 4.73 | 7.94 | 11.90 |
| Slow suction max. flow 50% | ml/h | 0.75 | 2 | 4 | 6 | 12 | 20 | 30 |
| | gph | 0.20 | 0.53 | 1.06 | 1.56 | 3.15 | 5.29 | 7.94 |
| Max. suction head in operation | m | 6 | 6 | 6 | 5 | 5 | 5 | 3 |
| Max. suction head, priming with empty head | m | 2 | 2 | 2 | 1.5 | 1.5 | 3 | 3 |
| Max. viscosity, std. valve (and minimum DN pipe) | mPa.s | 100 | 10 | 200 | 100 | 200 | 200 | 100 |
| Max. viscosity, M valve with spring (and DN15 pipe) | mPa.s | 3000 | 3000 | 3000 | 3000 | 2100 | 2000 | 600 |
| Max. viscosity, M valve SS1 with spring (and DN15 pipe) | mPa.s | 3000 | 3000 | 3000 | 3000 | 3000 | 3000 | 1800 |
| Max. viscosity, M valve SS2 with spring (and DN15 pipe) | mPa.s | 3000 | 3000 | 3000 | 3000 | 3000 | 3000 | 1800 |
| Valve connections | | 4x6 | 4x6 | 6x8/6x12 | 6x8/6x12 | 10x12 | 10x12 | 10x12 |
| Recommended minimum pipe DN (water and up to L=2 m) | mm | 4 | 4 | 6 | 6 | 10 | 10 | 10 |
| SUC L=2 m | mm | 4 | 4 | 6 | 6 | 10 | 10 | 15 |
| SUC L=5 m | mm | 4 | 4 | 10 | 10 | 15 | 15 | 20 |
| P max. suction | bar | 1 | 1 | 1 | 1 | 1 | 1 | 1 |
| Ambient T max. | C/F | 0...45 C / 32...113 F | | | | | | |
| T max. average | C/F | PP: 0...50C / 32...122 F; PVDF: -10...50C / 14...122 F; AISI316: -10...60 / 14...140 F | | | | | | |
| Relative humidity max.: | | 95% without condensation | | | | | | |
| Noise level | dB(A) | < 60 | | | | | | |
| Protection | | IP65 | | | | | | |
| Weight | Kg | 4.5 kg / 10 lb | | | | | | |
| Voltage | V | 100-250 vac / 22-30 vdc | | | | | | |
| Frequency | Hz | 50/60Hz | | | | | | |
| Power | W | 32 | | | | | | |
| Current | A | 0.14 A (230vac) / 0.24 A (110vac) / 1 A (24vdc) | | | | | | |

Inputs/outputs

- Analogue input 0/4-20 mA
- External pulse input
- Remote activation input (on/off)
- Level sensor input (pre-warning)
- Level sensor input (alarm)
- Leakage detector input
- Flow detector input
- Pressure sensor input
- RS-485 ModBus serial port
- 4-20 mA log and monitoring output
- Log output, monitoring and control of second pulse pump
- Alarm output (relay)
- Level alarm output (relay)

DIMENSIONS

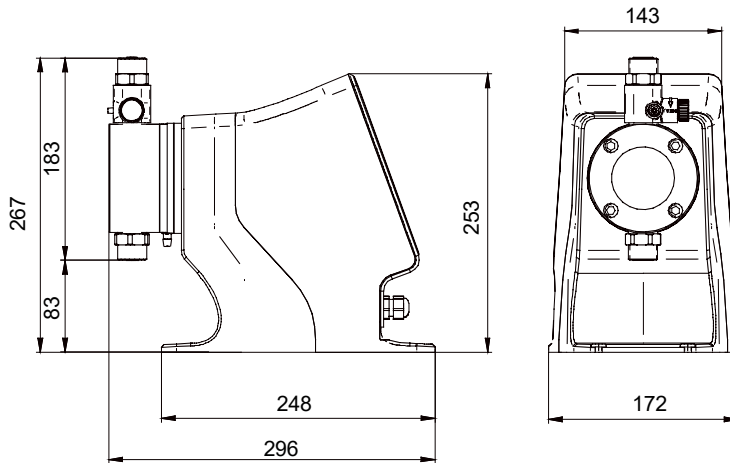

FLOW AND PRESSURE GRAPHS

— Pressure compensation activated
 - - - Pressure compensation deactivated

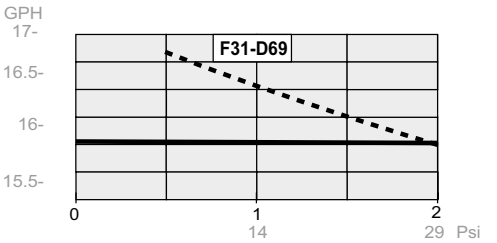
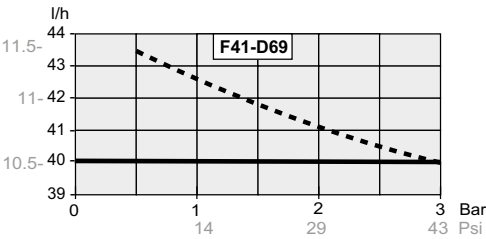
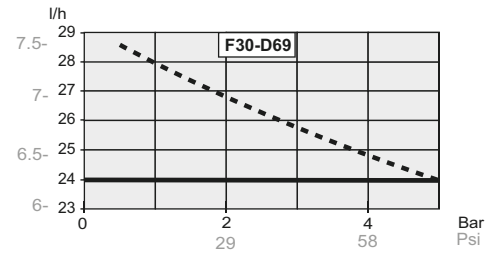
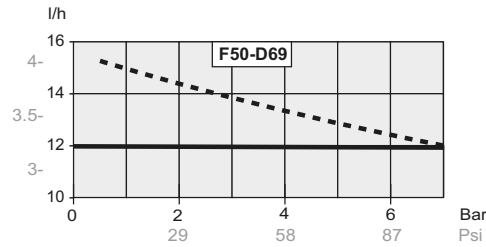
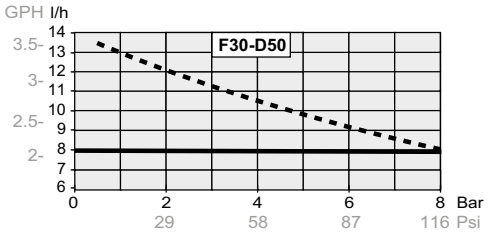
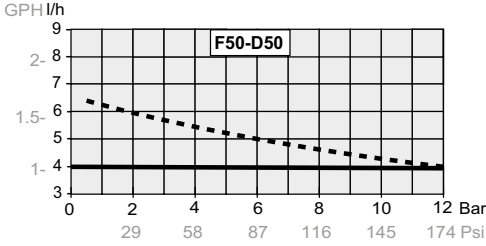
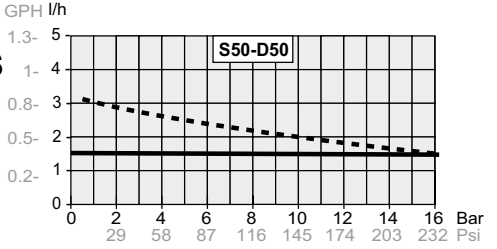

4 INSTALLATION

4.1 GENERAL

It should be installed in a place protected from water, away from heat sources and with renovation of air.

Fix the pump on a rigid horizontal surface. Provide enough space to comfortably perform basic maintenance and facilitate installation and removal.

Fix the pump to the chosen flat surface using 4 screws

(See drawing).

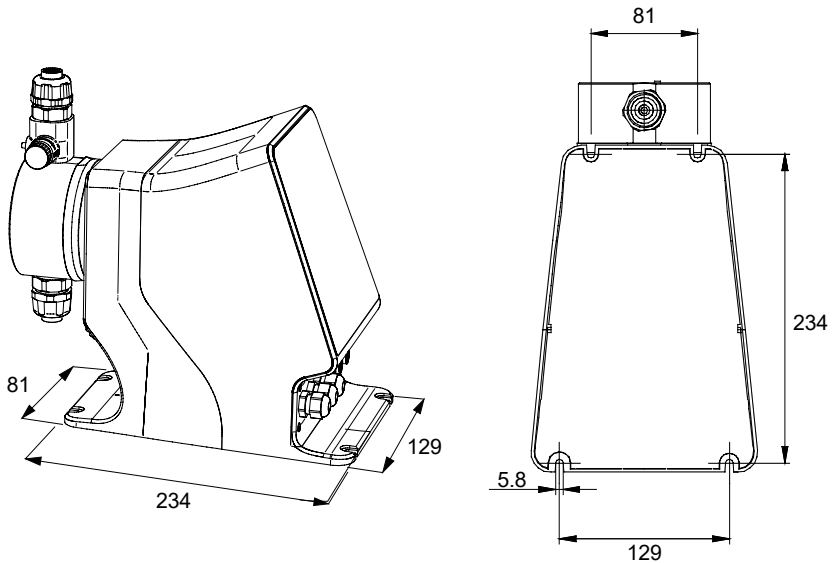

4.2 WIRING

The electrical protection of the motor must be installed and adjusted on the basis of its nominal current (thermomagnetic circuit breaker). (See connection).



A device for disconnection in case of emergency must be installed.

The equipment must be protected against false starts.

If the power cord is damaged, it must be replaced by the manufacturer, by its after-sales service or by similar qualified personnel in order to avoid any hazard.

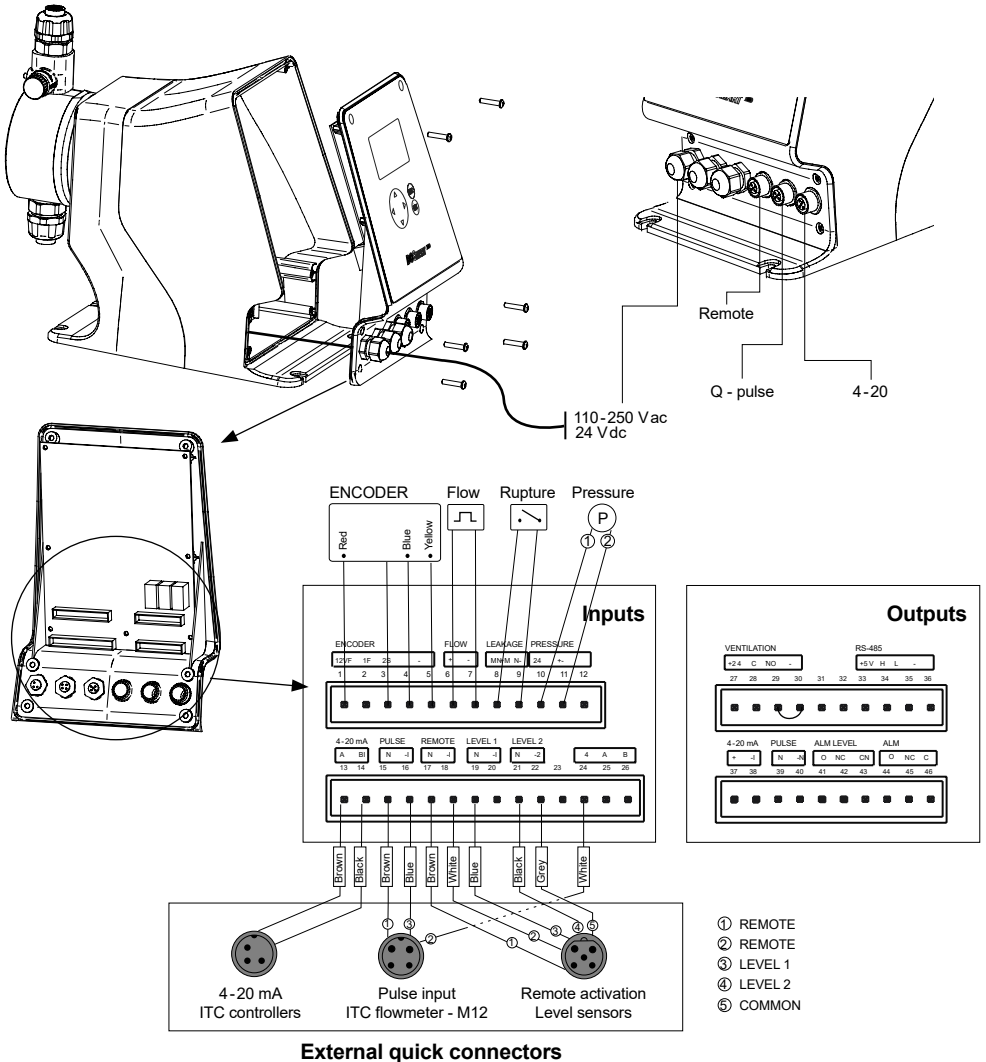

WIRING

| N | FUNCTION | DETAIL |
|----------------|-------------------------------|----------------------------|
| Inputs | | |
| 1 | Encoder | +12 Vdc |
| 2 | Encoder | F1 |
| 3 | Encoder | F2 |
| 4 | Encoder | S |
| 5 | Encoder | (-) |
| 6 | Flow detector | (+) |
| 7 | Flow detector | (-) |
| 8 | Leakage detector | (+) |
| 9 | Leakage detector | (-) |
| 10 | Pressure transmitter | +24 Vdc |
| 11 | Pressure transmitter | (+) |
| 12 | Pressure transmitter | (-) |
| 13 | 4-20 mA input analogue mode | (+) |
| 14 | 4-20 mA input analogue mode | (-) |
| 15 | Proportional pulse input mode | Pulses |
| 16 | Proportional pulse input mode | (-) |
| 17 | Remote | Voltage free contact |
| 18 | Remote | Voltage free contact |
| 19 | Level sensor 1 | Voltage free contact |
| 21 | Level sensor 2 | Voltage free contact |
| 22 | Common level sensor | Voltage free contact |
| Outputs | | |
| 33 | RS-485 | +5 Vdc |
| 34 | RS-485 | H (B) |
| 35 | RS-485 | L (A) |
| 36 | RS-485 | (-) |
| 37 | 4-20 mA monitor output | (+) Not isolated |
| 38 | 4-20 mA monitor output | (-) Not isolated |
| 39 | Monitor pulse output | Signal. Not isolated |
| 40 | Monitor pulse output | (-) Not isolated |
| 41 | Level alarm 2 output | NO |
| 42 | Level alarm 2 output | NC |
| 43 | Level alarm 2 output | Common (max. 5 A 250 V ac) |
| 44 | Alarm output | NO |
| 45 | Alarm output | NC |
| 46 | Alarm output | Common (max. 5 A 250 V ac) |

4.3 HYDRAULIC INSTALLATION

4.3.1 Installation examples

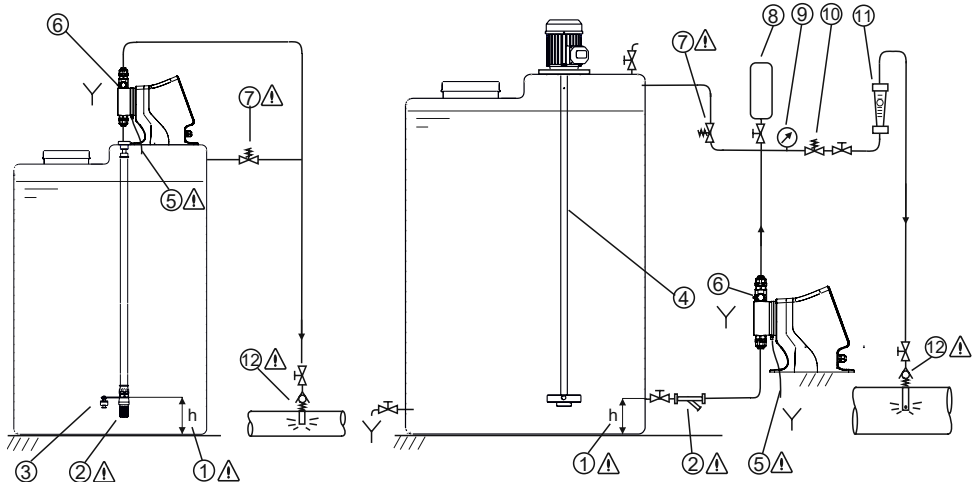

- ⚠ 1. To avoid undissolved particles, never suck the product to be injected from the bottom of the tank.
- ⚠ 2. Filter. It is essential to install a filter (150 micron) in the suction piping.
- 3. Level sensor
- 4. Agitator
- ⚠ 5. Make sure to connect a hose or pipe made of material compatible with the product dosed to the bottom of the cylinder at the drain hole in case of a rupture of the membrane and collect the liquid in a safe place.
- 6. Priming and drain valve built into the pump.
- ⚠ 7. Pressure relief valve. Install a pressure relief valve in a bypass as close as possible to the pump in order to protect the pump and the installation from possible overpressure. This bypass should pipe the liquid to a safe place.
- 8. Pulse dampener
- 9. Pressure gauge.
- 10. Pressure maintenance valve.
- 11. Flowmeter
- ⚠ 12. Injection check valve

4.3.2 Installation recommendations

SUCTION

⚠ Long suction: $L > 2$ m (6.5 ft)

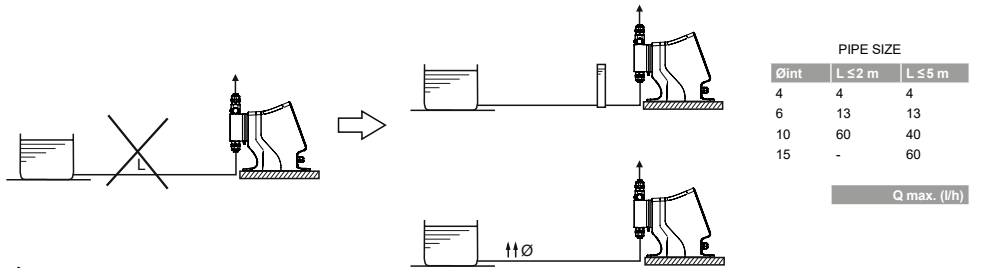

⚠ Air in suction

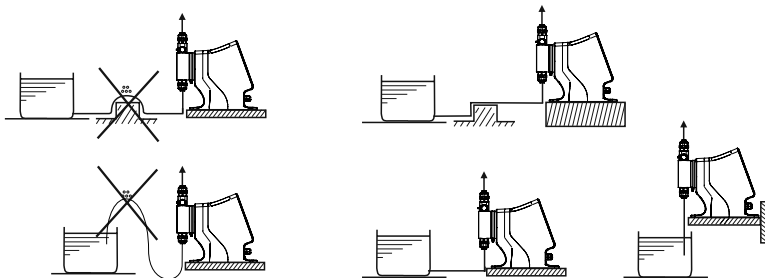

DISCHARGE

⚠ Long discharge: $L > 5$ m (16 ft)

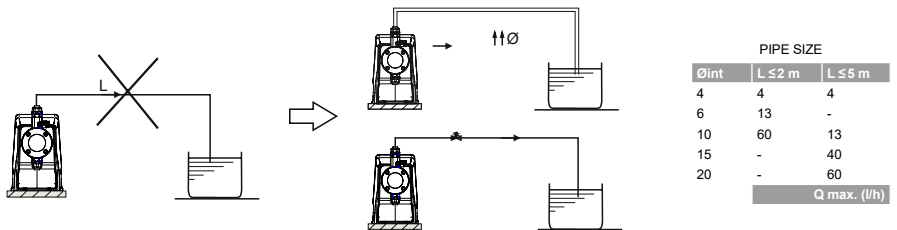

⚠ Siphon

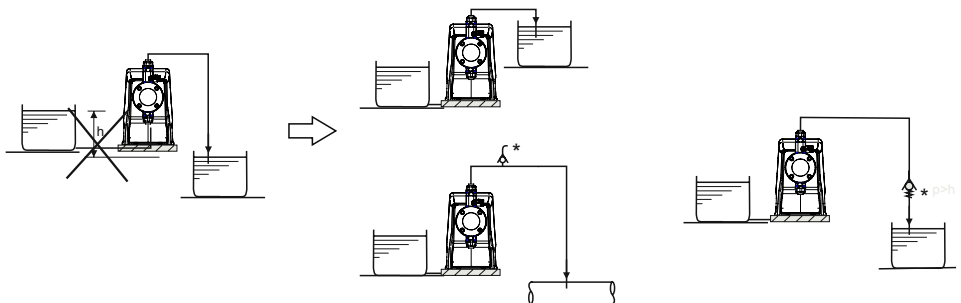

4.4 ACCESSORIES

4.4.1 Diaphragm leakage detector

The diaphragm leakage detector is an electrical conductivity sensor capable of detecting the presence of liquid when its conductivity is 0.05 mS or higher. The pump must be provided with the specific diaphragm flange for housing the detector.

| Diaphragm Ø | Diaphragm leakage sensor kit |
|-------------|------------------------------|
| 50 | 29-068-P |
| 69 | 29-063-P |

Fit the detector Ref. 29-056 in the lower opening of the diaphragm and connect pins 8-9 as shown in the drawing.

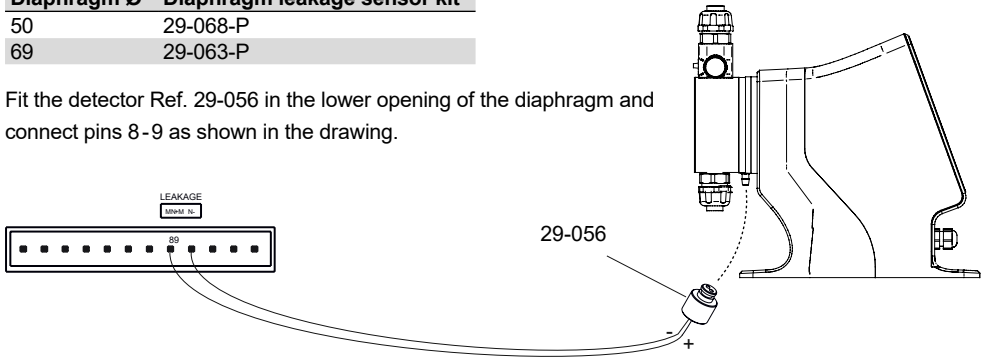

4.4.2 Pressure sensor

The pressure sensor protects the pump from working in overpressure conditions, when the pressure alarm is activated. Connect the 4-20 mA 10 bar pressure sensor Ref. 18705 as shown in the drawing.

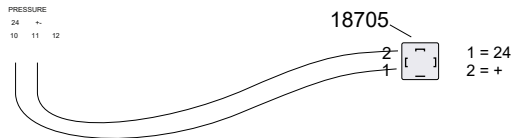

4.4.3 Pulse output isolator

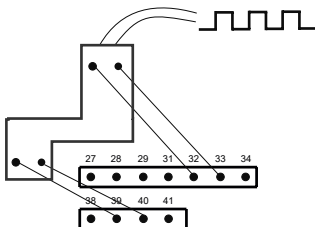

The pulse output isolator allows any device to be securely connected to a pulse output.

The pulse output is a voltage free output. The isolator is not necessary when the output is connected to a 38 39 40 41 pulse input of another DOSmart AC.

5 OPERATION

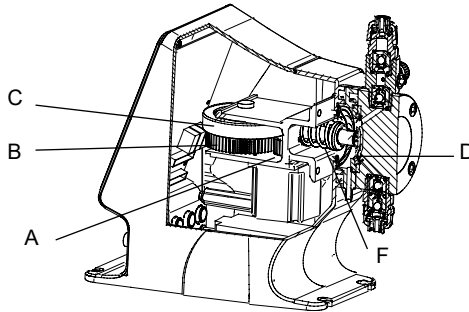

The electric motor transmits power via a reducer, consisting of a pinion (A) and an eccentric crown (B) that drives a connecting cam (C) onto which the diaphragm (D) is screwed. Spring (F) is compressed during the suction cycle, thus storing energy which is released during the delivery cycle.

By varying the speed of the motor and depending on the operating mode selected in the Control Unit, the equipment will regulate the flow to the desired value with a maximum variation of 1:3000.

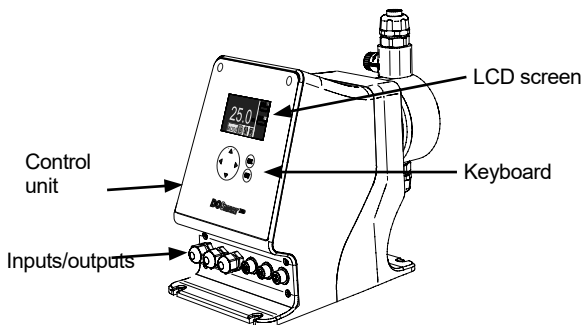
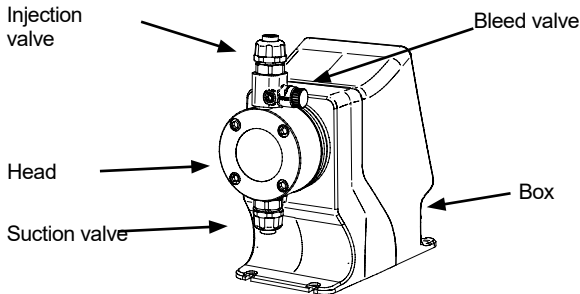

EQUIPMENT DESCRIPTION



-  Exit without confirming / 
-  Validate/Run/Stop
-   Increase/decrease value
-  Scroll left
-  Scroll right/test

LCD DISPLAY DESCRIPTION

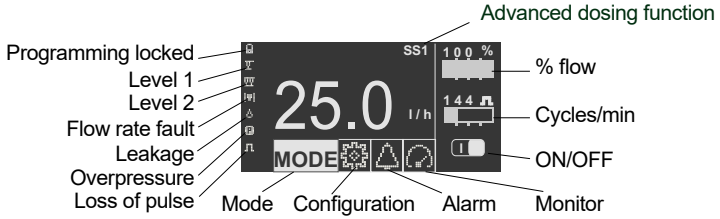

Menus

5.1 Operating modes



5.2 Configuration



5.3 Alarms

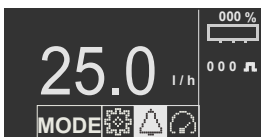

5.4 Monitor

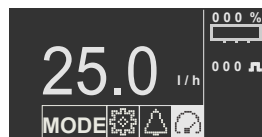

5.1 OPERATING MODES

5.1.1 Manual mode

This mode allows manual adjustment of the dosing flow rate.

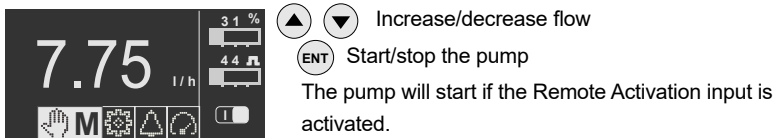
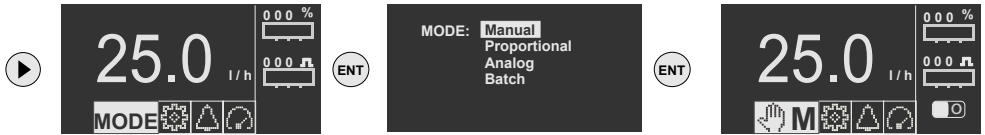

5.1.2 Proportional mode

This mode allows dosing to be proportional to a pulsed input. Use X:Y mode to establish a ratio of input pulses (X) to pump cycles (Y). Use the %/ppm mode for proportional dosing.

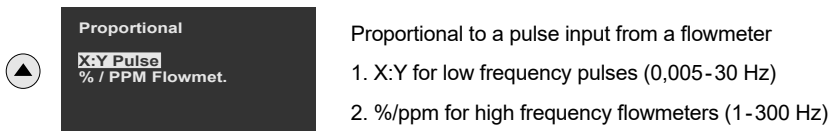
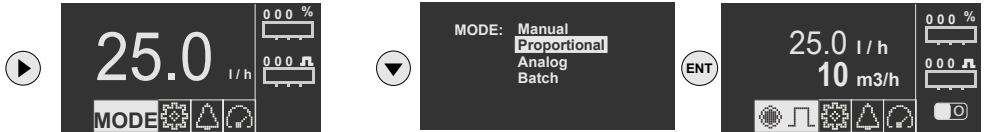

Proportional mode settings

5.1.2.1 X:Y pulses

The pump will cycle Y times after receiving X input pulses. The pump speed can be adjusted manually.

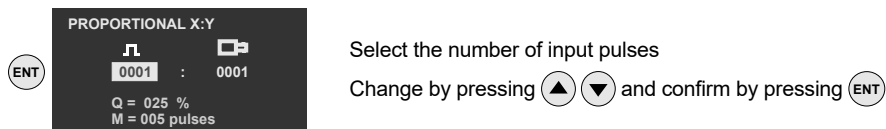

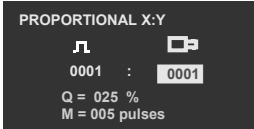

Select the number of pump cycles

Change by pressing and validate by pressing

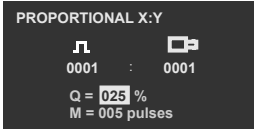

Select pump speed in %

Change by pressing and confirm by pressing

For Y=1 Q must be set at less than 50%

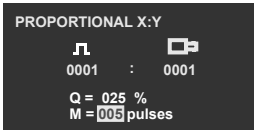

Select the maximum number of pulses in memory

Change by pressing and confirm by pressing



Start/stop the pump

The pump will start if the Remote Activation input is activated.

5.1.2.2 %/ppm Flowmeter

By entering a proportion value (%/ppm) and with a pulse input from a flowmeter, the pump will regulate its speed to dose the flow according to the desired proportion.

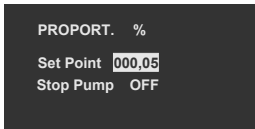

Proportionality value in % or ppm

Change by pressing and confirm by pressing

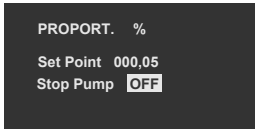

Select OFF to perform proportional dosing with no volume limit.

Change by pressing and confirm by pressing



Instantaneous water flow rate

Pressing will cause the ON/OFF indicator to toggle to ON and the pump will start if the Remote Activation input of is activated

* For the configuration of units (%/ppm) see Units in the Configuration section

* For flowmeter configuration. See the Configuration/Setup section

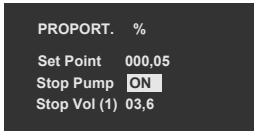

Select ON to perform proportional dosing with a volume limit. The pump will stop when it reaches the ENT maximum volume to be dosed.

Change by pressing and confirm by pressing

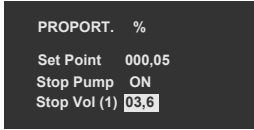

Set the desired maximum volume.

Change by pressing and validate by pressing

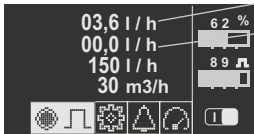

Volume to be dosed

volume dosed

By pressing ENT the ON/OFF indicator will change to ON and the pump will start if the Remote Activation input is activated.

The pump will stop when it reaches the maximum volume set.

5.1.3 Analogue mode

This mode allows dosing proportional to an analogue 0/4-20 mA input.

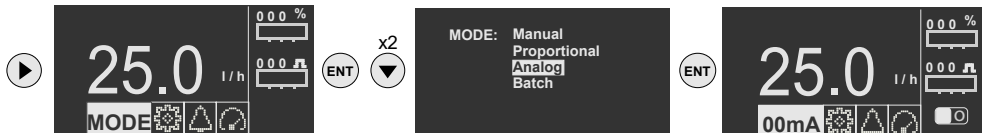

5.1.3.1 Analogue mode configuration

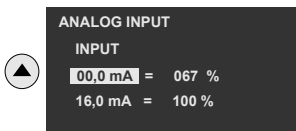

Select mA input for the first point

Change by pressing and confirm by pressing

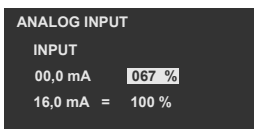

Select the flow in % for the first point in mA

Change by pressing and confirm by pressing

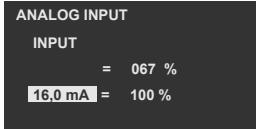

Select mA output for the second point
Change by pressing and confirm by pressing

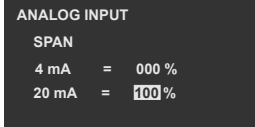

Select the flow rate in % for the second point in mA
Change by pressing and confirm by pressing



Start/stop the pump
The pump will start if the Remote Activation input is activated

Examples:

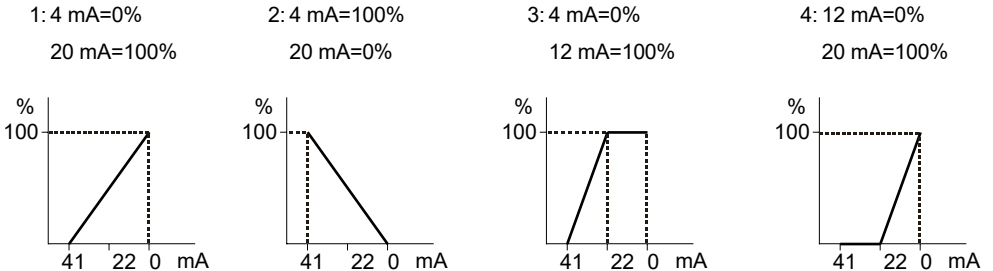

Examples 3 and 4 can be combined into two pumps when both are controlled with the same mA signal to start a second pump as supplementary flow.

5.1.4 Batch dosing mode

This mode allows batch dosing. Various activation options may be chosen (manual, external, time), and an end of the work cycle defined by number of cycles/volume or by time. In any of the operating modes, the speed of the pump can be defined in %.

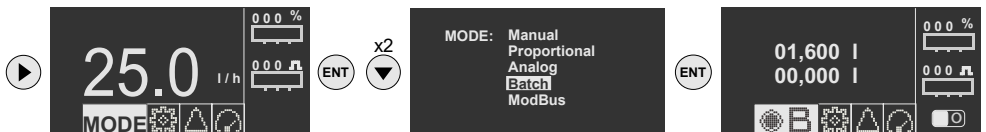



Batch dosing mode settings

5.1.4.1 Select start-up mode

 BATCH MODE

| | |
|-------|--------|
| Start | Man. |
| Flow | 000 % |
| Stop | Stroke |

Manual: start the pump by pressing 

 BATCH MODE

| | |
|-------|--------|
| Start | Ext. |
| Flow | 000 % |
| Stop | Stroke |

Ext.: start the pump via remote input

 BATCH MODE



| | |
|-------|--------|
| Start | Time |
| Flow | 000 % |
| Stop | Stroke |

Time: start the pump using a timer by entering a frequency (00:00:01-23:59:59)

5.1.4.2 Select stroke frequency in % (flow)

 BATCH MODE

| | |
|-------|--------|
| Start | Man. |
| Flow | 050 % |
| Stop | Stroke |

Change by pressing   and confirm by pressing 

5.1.4.3 Select stop mode



BATCH MODE

| | |
|-------|--------|
| Start | Man. |
| Flow | 050 % |
| Stop | Stroke |

Stroke: select the number of cycles before stopping

 BATCH MODE

| | |
|--------|-----------|
| Start | Man. |
| Flow | 050 % |
| Stop | 000050 St |
| Volume | 208,15ml |

Change by pressing   and confirm by pressing 

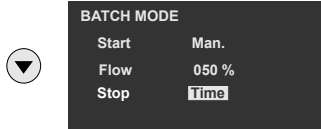

Time: set cycle execution time before stopping

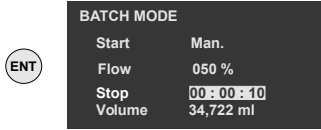

Change by pressing and confirm by pressing

Viewing the different configuration modes

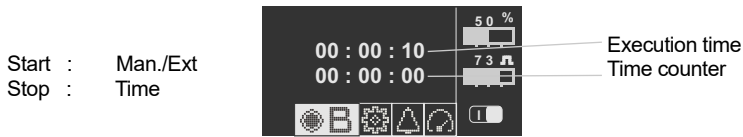
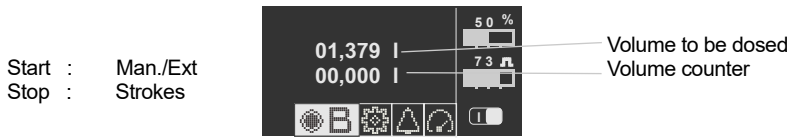

5.1.5 Special functions

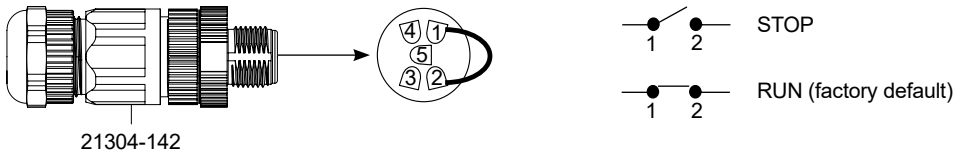

5.1.5.1 Remote activation

An external remote control can be used to start and stop the pump via volt-free contact at positions 17 - 18.



When the contact is closed (RUN) the pump may be run manually via the ENT key. After stopping the pump manually via the keypad, it is necessary to reset the Remote Input (open and close) to start the pump again remotely.

5.1.5.2 Priming function test

By pressing  for 3 seconds in manual mode, to start the pump at maximum speed. The pump will continue to run only when  is pressed.

This feature allows a quick test of the unit and is an aid in priming the pump.

5.2 CONFIGURATION

5.2.1 Pump calibration

The pump calibration function allows the pump flow to be calibrated in real working conditions via a product suction test of a given duration. For a correct calibration, a test duration of at least 60 seconds must be entered. The pump will automatically start during the time of the test.

Once the test is finished, the suction volume must be entered. With this result the equipment will recalculate the dosing flow.

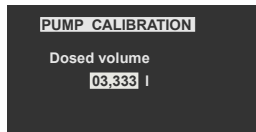
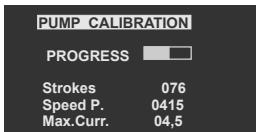
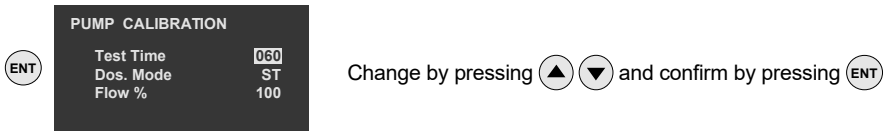
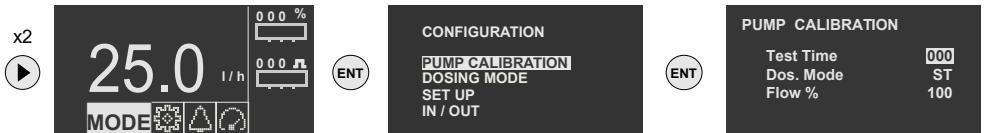

Enter the value in the unit and confirm by pressing

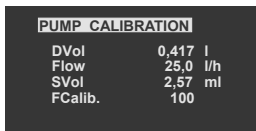

Press to finish the calibration process
 Dvol: volume dosed
 Flow: flow rate
 S.Vol: volume per cycle
 F.calib: calibration factor
 Reduct: Reducer

5.2.2 Dosing mode

The Dosing Mode function allows the various Advanced Dosing Functions to be selected. These functions can regulate the speed of the mechanism during the suction and delivery cycle of the pump in order to optimize the dosing and suit it to the characteristics of the process.

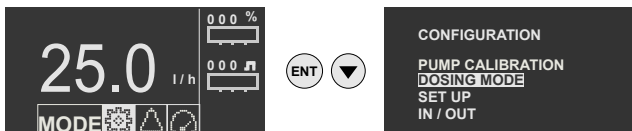

5.2.2.1 Low pulsation standard

The Standard ST mode is the normal operating mode where the doser has symmetrical behaviour during suction and delivery of the product while working at maximum capacity. As the flow rate is reduced, the delivery cycle is extended, keeping the suction duration constant.

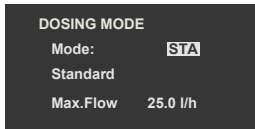

100% operation

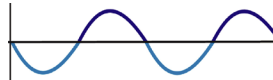

50% operation

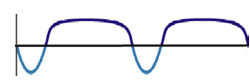

Change by pressing ▲ ▼ and validate by pressing ENT

5.2.2.2 Slow suction SS1

The Slow Suction 1 (SS) mode reduces the speed during the suction cycle while increasing the pressure cycle to compensate for the loss of flow. In this way, the accuracy of the dosing of viscous liquids is improved, since the risk of cavitation and incomplete filling of the head is reduced. Suction is carried out at 50% of the speed of Standard mode, but the final flow is reduced to only 75%.

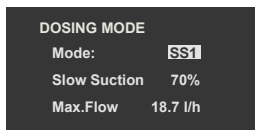

Change by pressing ▲ ▼ and validate by pressing ENT

5.2.2.3 Slow suction SS2

The Slow Suction 2 (SS) mode reduces the speed during the suction and delivery cycle. The suction operation is as described for Slow Suction 1, and the delivery cycle speed is also reduced to 50% to avoid overpressure in long deliveries. In this mode the flow is reduced to 50%

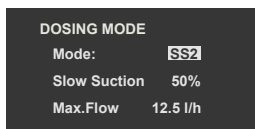

Change by pressing ▲ ▼ and validate by pressing ENT

5.2.3 Configuration

5.2.3.1 Dosing pump

Technical characteristics of the pump

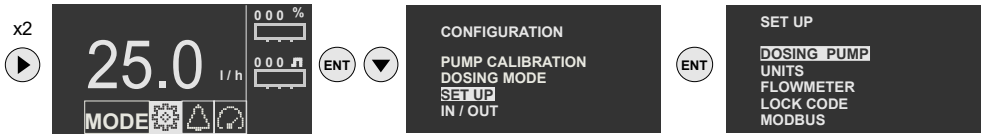

Pump flow rate

Real Flow is the flow rate resulting from the calibration, if it has been performed. Max. Flow is the resulting flow according to the limit and/or selected dosing profile.

| DOSING PUMP | |
|-------------|----------|
| Flow | 25.0 l/h |
| Flow max | 12.5 l/h |
| Limit | 100 % |
| Pres. Alm | 05.0 Bar |
| Pres. Comp | Off |



Limited flow %

This is the maximum limited flow of the pump. It limits the pump flow so that it does not exceed the entered value under any circumstances.

| DOSING PUMP | |
|-------------|----------|
| Flow | 25.0 l/h |
| Flow max | 12.5 l/h |
| Limit | 100 % |
| Pres. Alm | 05.0 Bar |
| Pres. Comp | Off |

Change by pressing and confirm by pressing

Maximum pressure

Dosing pump maximum working pressure

| DOSING PUMP | |
|-------------|----------|
| Flow | 25.0 l/h |
| Flow max | 12.5 l/h |
| Limit | 100 % |
| Pres. Alm | 05.0 Bar |
| Pres. Comp | Off |

Change by pressing and validate by pressing

Compensation of working pressure

Flow compensation as a function of working pressure

| DOSING PUMP | |
|-------------|----------|
| Flow | 25.0 l/h |
| Flow max | 12.5 l/h |
| Limit | 100 % |
| Pres. Alm | 05.0 Bar |
| Pres. Comp | Off |

Change by pressing and validate by pressing

Auto: If the pump has a pressure sensor connected, by selecting this option the pump will keep the flow unchanged even if the working pressure changes.

Manual (MAN): If the pump does not have a pressure sensor, but the working pressure is constant, the pressure value can be entered manually so that the pump adjusts to the nominal flow value.

| DOSING PUMP | |
|-------------|----------|
| Flow | 25.0 l/h |
| Flow max | 12.5 l/h |
| Limit | 100 % |
| Pres. Alm | 05.0 Bar |
| Pres. Comp | Off |

Change by pressing ▲ ▼ and confirm by pressing ENT

With no compensation (OFF): The pump flow will be as shown in the curves on page 8.

5.2.3.2 Units

Select the units for flow, pressure and proportionality

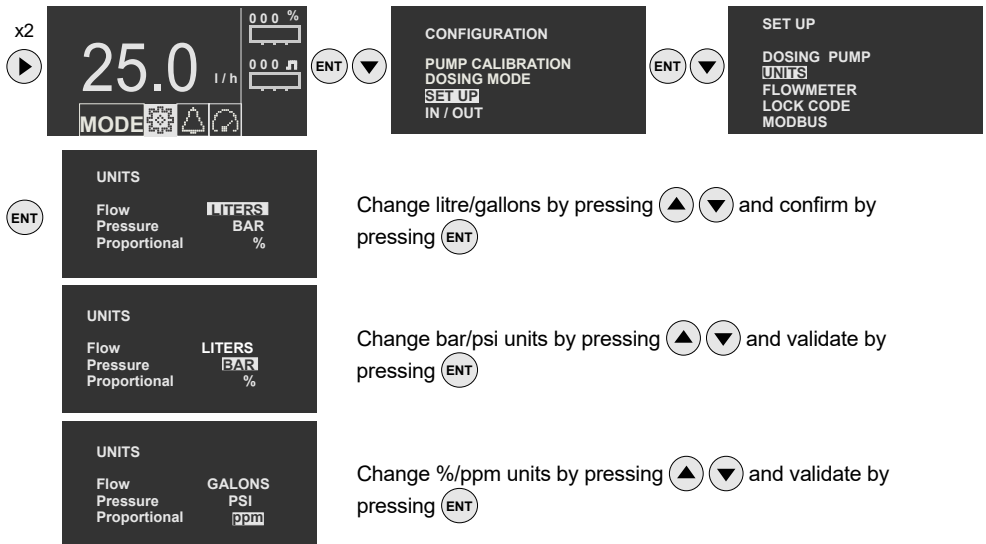

5.2.3.3 Flowmeter

For a correct water flow reading, the flowmeter constant (volume/pulse or pulses/volume) must be entered. Previously select the type of flowmeter for low or high frequency.

Low frequency: for water meters with low frequency outputs (0.005 Hz to 30 Hz). The constant is expressed in volume/pulse (litres/pulse; gallons/pulse).

High frequency: for flowmeters with high frequency outputs (1 to 300 Hz). The K-factor constant is expressed in pulses/volume (pulses/litre; pulses/gallon).

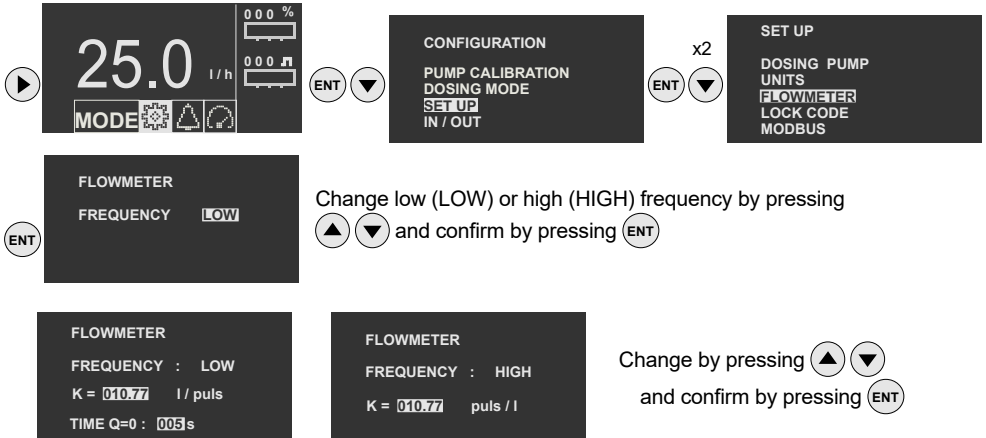

TIME Q=0, Time interval (seconds) between two pulses to consider zero flow.

5.2.3.4 Lock code

Blocks access to the equipment configuration, allowing the pump to start and stop. When the access code is 0000 (default value), the lock is disabled.

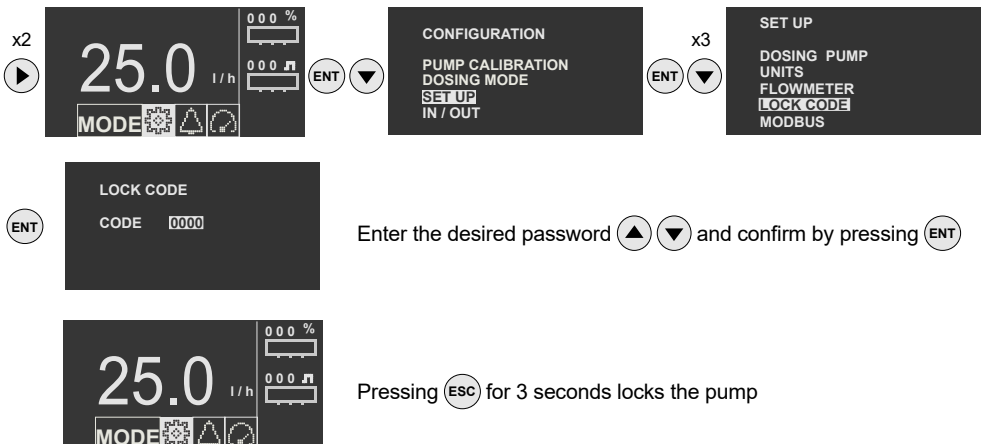

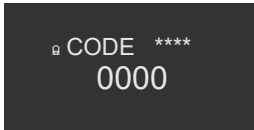

Press **(ESC)** for 3 seconds to enter the code and unlock the pump

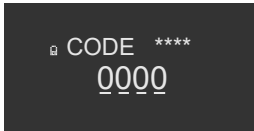

Enter the code starting with the units (from right to left).
Change values by pressing **(▲)** **(▼)** and validate by pressing **(ENT)**

5.2.3.5 ModBus

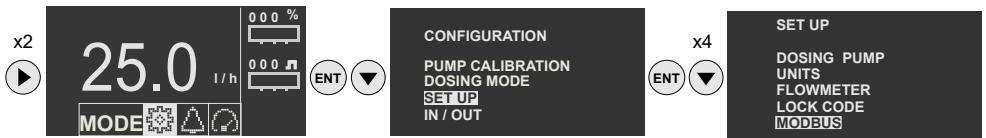

5.2.3.5 ModBus

The pump can be controlled via the RS485 serial port and a ModBus RTU protocol. See the complete ModBus manual.

- Bus: RS485
- Communication: half-duplex L(H), H(B), and GND
- Baud rate: 9600
- Data bits: 8
- Parity: None
- Stop bits: 1
- Hardware handshake: No
- Character time out: 20 ms
- Time out message end: 100 ms

Important: If an RS232RS485 or similar type converter is required, make sure that the signal emitted does not produce an echo.

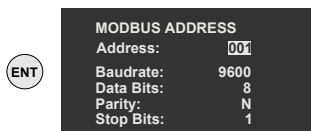

Change by pressing **(▲)** **(▼)** and confirm by pressing **(ENT)**

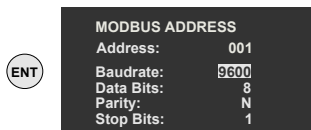

Change by pressing **(▲)** **(▼)** and confirm by pressing **(ENT)**

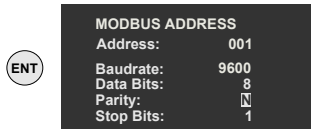

Change by pressing **(▲)** **(▼)** and confirm by pressing **(ENT)**

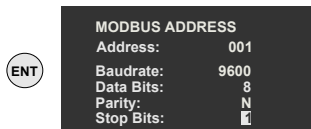

Change by pressing **(▲)** **(▼)** and confirm by pressing **(ENT)**

5.2.4 Inputs/outputs

5.2.4.1 Pressure input

Calibration of the 4-20 mA pressure transducer input.

25.0 l/h
MODE [Icons]

000.0 %
000.0

ENT ▼

CONFIGURATION
PUMP CALIBRATION
DOSING MODE
SET UP
IN/OUT

ENT

INPUTS
PRESSURE FLOW DETECTOR
OUTPUTS PULSES
4-20mA

PRESSURE INPUT
4 mA 000.0 bar
20 mA 000.0 bar

Enter the pressure value corresponding to 4 mA
Change by pressing ▲ ▼ and confirm by pressing ENT

PRESSURE INPUT
4 mA 000.0 bar
20 mA 020.0 bar

Enter the pressure value corresponding to 20 mA
Change by pressing ▲ ▼ and confirm by pressing ENT

5.2.4.2 Flow detector

The flow detector is an accessory that allows the pulses of the supplied flow to be monitored.

25.0 l/h
MODE [Icons]

000.0 %
000.0

ENT ▼

CONFIGURATION
PUMP CALIBRATION
DOSING MODE
SET UP
IN/OUT

ENT

INPUTS
PRESSURE FLOW DETECTOR
OUTPUTS PULSES
4-20mA

FLOW DETECTOR IN
Strokes Pump 010

Enter the number of pump cycles during which no pulse is detected for the alarm to be activated.
Change by pressing ▲ ▼ and validate by pressing ENT

5.2.4.3 Pulse output

Configuration of the pulse output for monitoring or activation of a second pump.

25.0 l/h
MODE [Icons]

000.0 %
000.0

ENT ▼

CONFIGURATION
PUMP CALIBRATION
DOSING MODE
SET UP
IN/OUT

ENT

INPUTS
PRESSURE FLOW DETECTOR
OUTPUTS PULSES
4-20mA

PULSE OUTPUT
Out = Pulse In

Set whether the pulse output is the same as the pulse input.
With this option a second Dostec AC can be controlled by the same flowmeter in proportional mode (%).

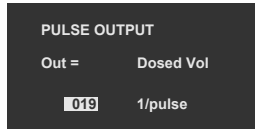
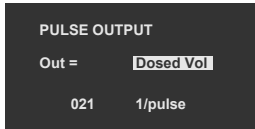

Enter the volume of product dispensed for each product.

Change by pressing and confirm by pressing

With this option another device can receive the dosed volume. Review 5.5.4 for connections.

5.2.4.4 4-20 mA output

4-20 mA output for log or monitoring.

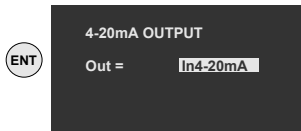
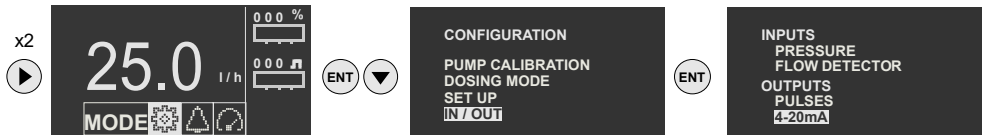

Set whether the pulse output is the same as the pulse input.

Change by pressing and confirm by pressing

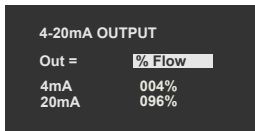

Enter the % flow rate at which the 4 mA will be emitted

Enter the % flow rate at which the 20 mA will be emitted

Change by pressing and confirm by pressing

5.2.5. Maintenance

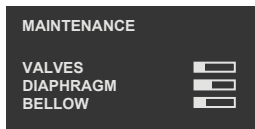

In the Maintenance menu, the status of components subject to wear can be viewed using the status bars.

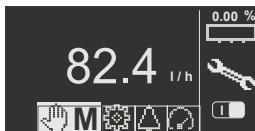

A warning will appear on the main screen at the end of the useful life of a component.

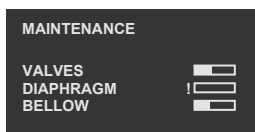

The status bars in the maintenance menu show the remaining life of each component and display a when the bar VAC, with this being the recommended time to replace the component.

You can view the cycles completed by selecting each component. A negative cycle value indicates that it has exceeded the maintenance interval.

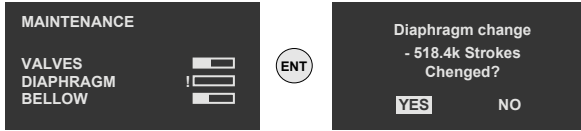

When replacing a component that has reached the end of its useful life, the cycle counter must be set to zero by using the YES option.

5.3 ALARMS

In the event of an alarm, the corresponding icon will flash on the main screen. If the cause of the alarm disappears the icon will remain steady. To erase the alarm icon, it is necessary to stop and start the pump using the "ENT" key. The security time is 5 seconds before any alarm is activated.

5.3.1 Level alarm 1

Low level pre-warning according to Level 1 input. Automatic reset (see connection 4.2).

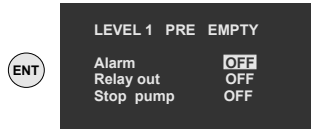
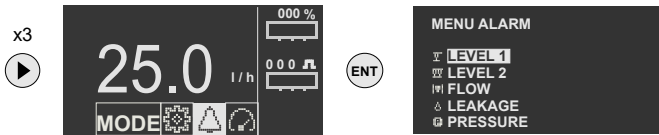

Activate or deactivate the alarm by pressing and confirm by pressing .

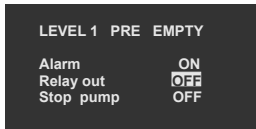

Activate or deactivate the Alarm Relay output, when the unit is in alarm, by pressing and confirm by pressing .

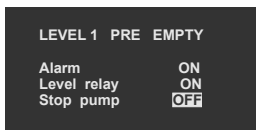

Activate or deactivate, stop the pump when the alarm goes off, by pressing and validate by pressing .

5.3.2 Level alarm 2

Low level alarm according to Level 2 input. Automatic reset (see connection 4.2).

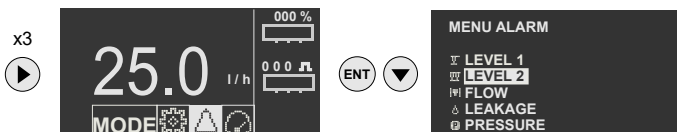

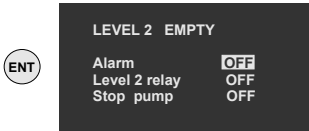

Activate or deactivate the alarm by pressing and confirm by pressing

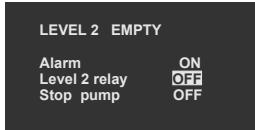

Activate or deactivate the Alarm Relay output, when the unit is in alarm, by pressing and confirm by pressing

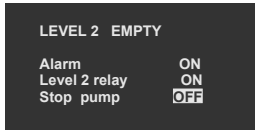

Activate or deactivate, stop the pump when the alarm goes off, by pressing and validate by pressing

5.3.3 Flow fault alarm

Dosing flow detector alarm.

See section 4.2.4.2 (Configuration/Inputs/Flow Detector)

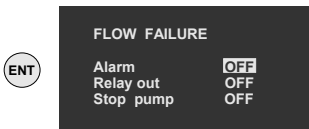
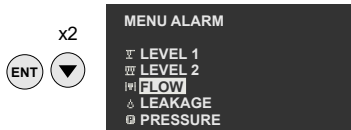

Activate or deactivate the alarm by pressing and confirm by pressing

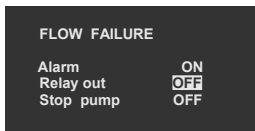

Activate or deactivate the Alarm Relay output, when the unit is in alarm, by pressing and confirm by pressing

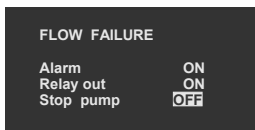

Activate or deactivate, stop the pump when the alarm goes off, by pressing and validate by pressing

5.3.4 Diaphragm leakage alarm

Diaphragm leakage detection alarm for electrically conductive liquids (min. 0.05 ms).

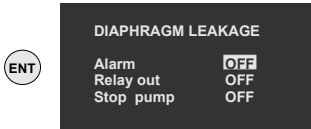
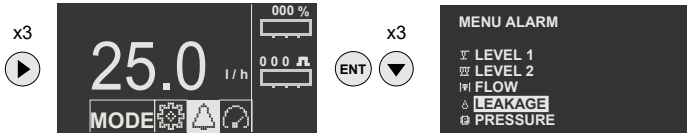

Activate or deactivate the alarm by pressing and confirm by pressing .



Activate or deactivate the Alarm Relay output, when the unit is in alarm, by pressing and confirm by pressing .

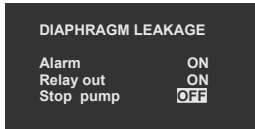

Activate or deactivate, stop the pump when the alarm goes off, by pressing and validate by pressing .

5.3.5 Overpressure alarm

Overpressure detection alarm. Automatic reset.

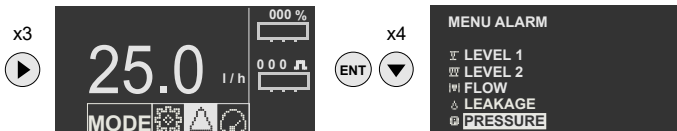

Activate or deactivate the alarm by pressing and confirm by pressing .

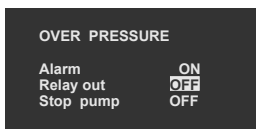

Activate or deactivate the Alarm Relay output, when the unit is in alarm, by pressing and confirm by pressing .

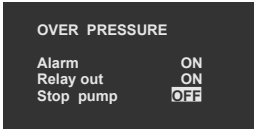

Activate or deactivate, stop the pump when the alarm goes off, by pressing ▲ ▼ and validate by pressing ENT

5.4 MONITOR

5.4.1 Real time

Real-time working parameters

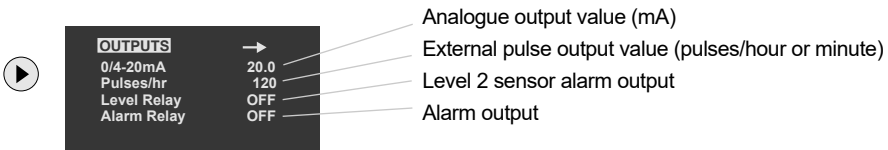
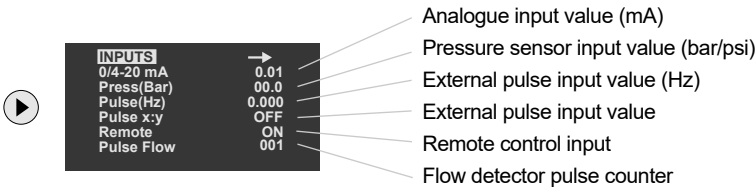
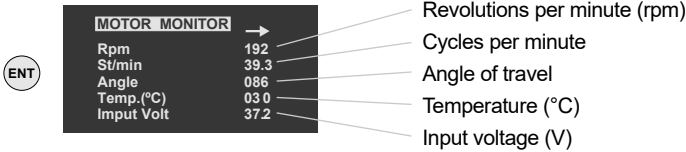
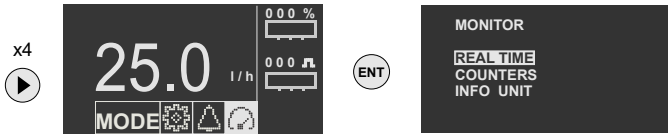

5.4.2 Counters

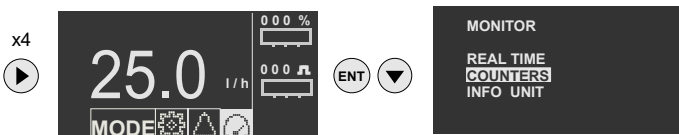

COUNTERS

| | |
|-------------|-------|
| Tot. St. | 27136 |
| Part. St. | 2971 |
| Part. Vol.2 | |
| Total(h) | 46 |

ENT

- Total cycles
- Cycles since last reset
- Volume since last reset
- Total operating time (hours)

COUNTERS

| | |
|------------|----|
| Sh. circ. | 0 |
| Over load | 32 |
| Over temp | 0 |
| Th. Shdwn | 0 |
| Load open | 3 |
| Volt range | 0 |

ENT

- Short circuit alarms
- Overload alarms
- High temperature alarms
- High temperature alarms (chip)
- Motor connection fault alarms
- Input voltage alarms

RESET COUNTERS

ENT.. = YES
ESC.. = NO

ENT

Press ENT to reset the cycle and volume counters or ENT not to reset them

5.4.3 Info Unit

x4

25.0 l/h

MODE

ENT

x2

MONITOR

REAL TIME
COUNTERS
INFO UNIT

INFO UNIT

55-001

| | |
|-----------|------|
| Serial N. | 1000 |
| Flow l/h | 1.50 |
| Press Ba | 16.0 |
| Stk/min | 050 |

ENT

- Unit code
- Serial number
- Nominal pump flow (l/h or GPH)
- Maximum pressure (bar or psi)
- Cycles/min

INFO UNIT

| | |
|------------|--------|
| Vol/St ml | 00.505 |
| Gear | 4.85 |
| K. Calib | 100 |
| HW version | 4204 |
| SW version | 5.07 |

ENT

- Cycle volume
- Reducer
- Calibration factor
- Hardware version
- Software version

6 START-UP AND REGULATION

- ⚠ FIXING: Check that the pump is properly secured
- ⚠ HYDRAULIC CIRCUIT CHECK: Check that all valves are open, and that the bleed and relief valve outlets are diverting the liquid to a container
- ⚠ PUMP CHECK: Make a visual/auditory check of the correct operation of the pump.
- ⚠ PRIMING: To facilitate pump priming, open the priming valve.
- ⚠ OVERPRESSURE PROTECTION: Adjust the safety, overpressure or pressure relief valve to the desired pressure to protect the installation, while never exceeding the nominal pressure of the pump.

7 MAINTENANCE

SPARE PARTS

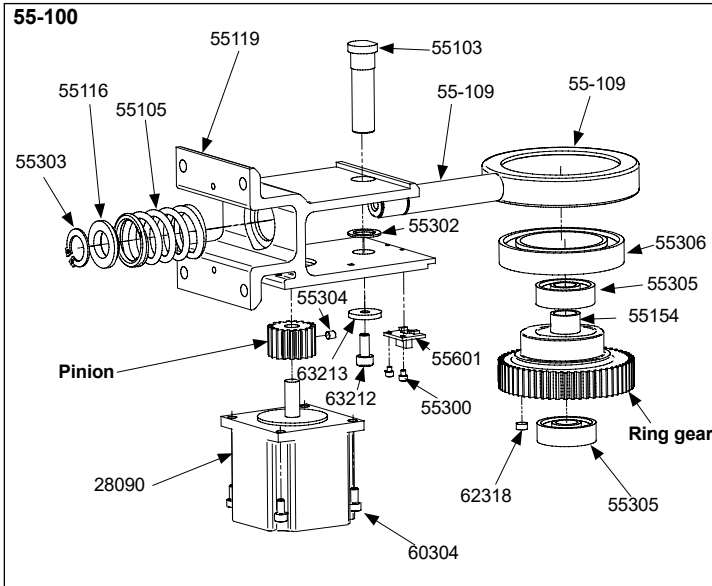
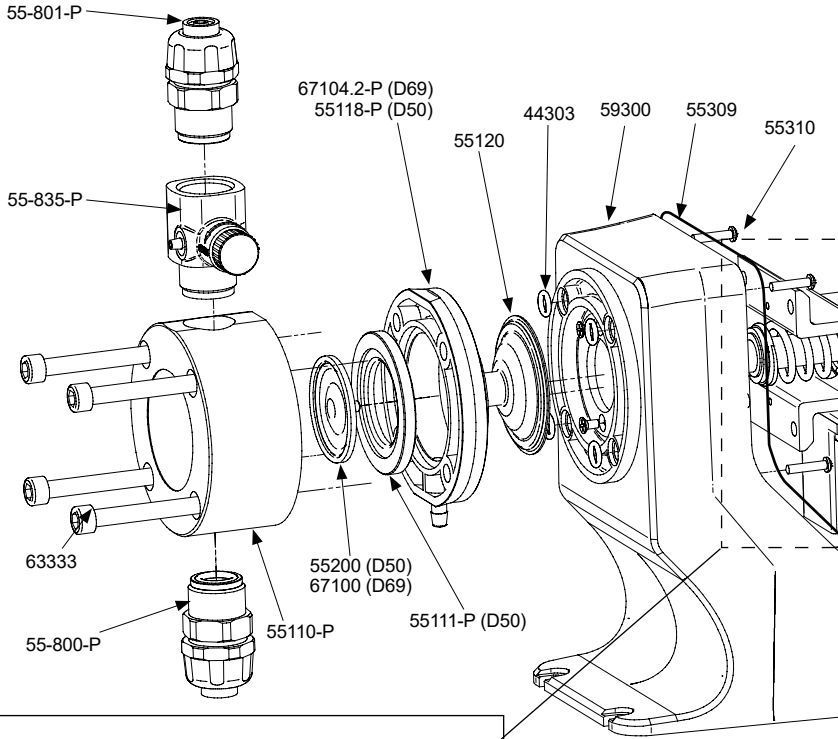

| MODEL | RING GEAR | PINION |
|---------|-----------|--------|
| S50-D50 | 55132 | 55129 |
| F50-D50 | 55132 | 55129 |
| F30-D50 | 55133 | 55106 |
| F50-D69 | 55132 | 55129 |
| F30-D69 | 55133 | 55106 |
| F41-D69 | 55130 | 55128 |
| F31-D69 | 55107 | 55106 |

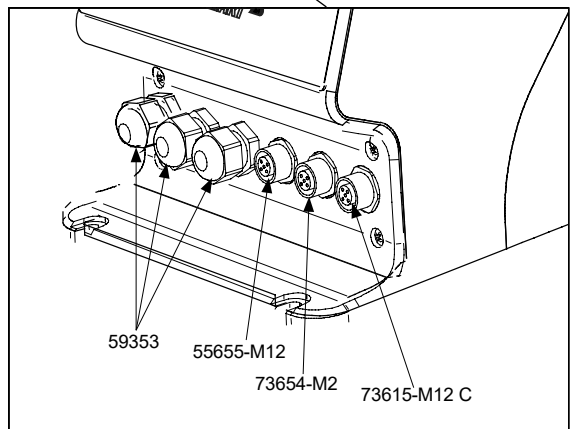
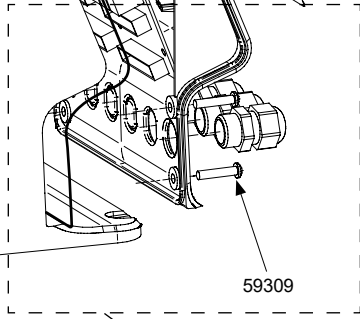
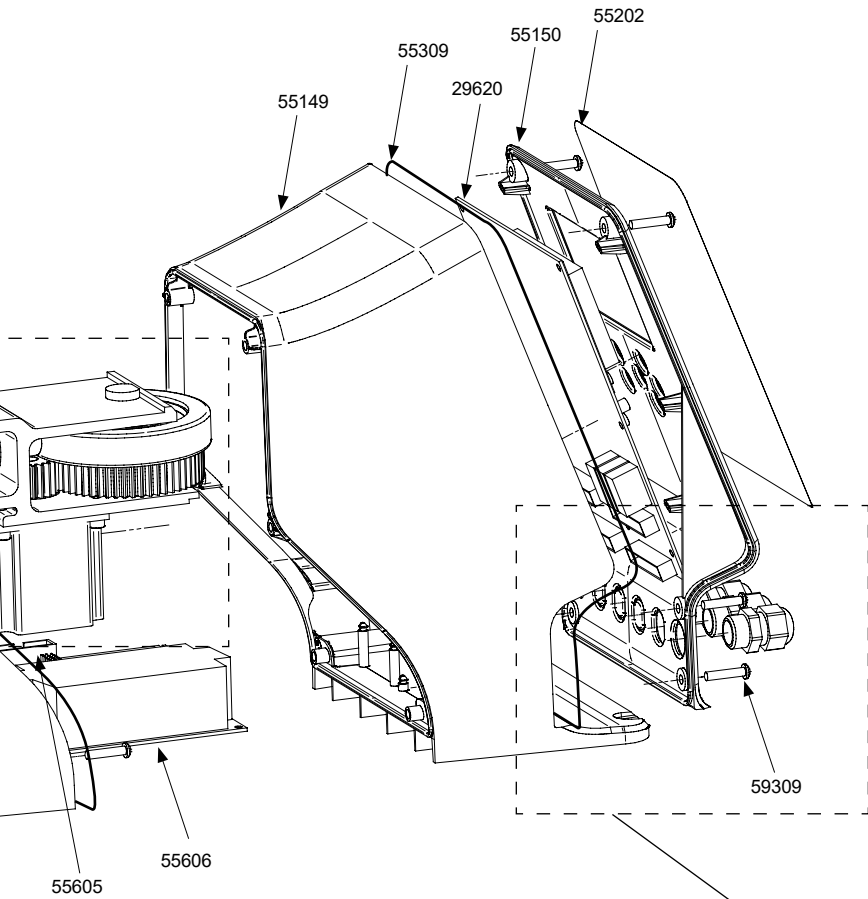

PARTS LIST

| CODE | DESCRIPTION | QUANTITY |
|-------------|--------------------------------------|-----------------|
| 28090 | Power supply 240 Vac 24 Vac | 1 |
| 29620 | AC control PCB plate | 1 |
| 44303 | 7.5x2.5 FPM O-ring | 4 |
| 55103 | Dosmart shaft | 1 |
| 55105 | Dosmart spring | 1 |
| 55-109 | Dosmart cam | 1 |
| 55110-P//F | Diaphragm cylinder D50 | 1 |
| 55111-P/F | D50 diaphragm base | 1 |
| 55116 | Dosmart Cam spring stop | 1 |
| 55118-P//F | D50 diaphragm base | 1 |
| 55119 | Dosmart Machined mechanism support | 1 |
| 55120 | Dosmart bellows | 1 |
| 55148 | Dosmart Hydraulics housing | 1 |
| 55149 | Dosmart Electronics housing | 1 |
| 55150 | Front Dosmart Electronics housing | 1 |
| 55154 | Dosmart Shaft bushing | 1 |
| 55200 | D50 diaphragm | 1 |
| 55202 | Lexan DOSMART | 1 |
| 55300 | Allen bolt M2,5x3 DIN 912 | 2 |
| 55302 | Fitting washer 12x18x1 DIN 988 | 1 |
| 55303 | D15 DIN 471 safety ring | 1 |
| 55304 | Allen screw M4x4 DIN 913 | 1 |
| 55305 | Bearing 6201-2RSH (12x32x10) | 2 |
| 55306 | Bearing 61909-2RS (45x68x12) | 2 |
| 55310 | Bolt 4x20 E0210 A2 | 6 |
| 55601 | Dosmart Hall Sensor PCB | 1 |
| 55605 | Dosmart power plate PCB | 1 |
| 55655-M12 | 3 pin male panel connector | 1 |
| 55-800-P//F | Double ball suction valve L ¾ 4-6-10 | 1 |
| 55-801-P//F | Delivery valve L ¾ 4-6-10 | 1 |
| 55-835-P/F | Dosmart priming valve L ¾ | 1 |
| 55309 | Gasket 2 mm EPDM25 | 2 |
| 59300 | Bolt M4x8 DIN965 A2 | 2 |
| 59309 | Bolt 4x16 E0210 A2 | 6 |
| 59353 | Cable gland M16 white | 3 |
| 60304 | Bolt M4x8 DIN912 A4 | 4 |
| 62318 | Ferrite D6x3 sxp magnet | 1 |
| 63212 | Allen bolt M5x12 DIN912 A4-80 | 1 |
| 63213 | Motor washer F5 18x5x2.5 | 1 |
| 63333 | Screw M8x80 DIN912 A2 | 4 |
| 67100 | D69 diaphragm | 1 |
| 67104.2-P/F | D69 diaphragm base | 1 |
| 67105.2-P/F | D69 Diaphragm cylinder | 1 |
| 73615-M12 | 4-20 mA hose cable + connector | 1 |
| 73654-M2 | 150mm flow hose cable | 1 |





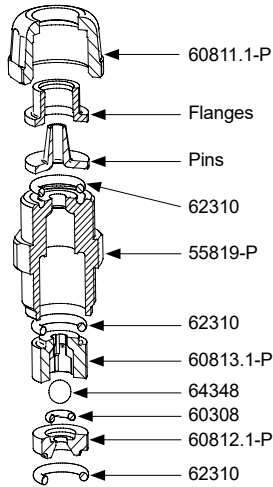

6 x 12 VALVES (60 l/h max.)

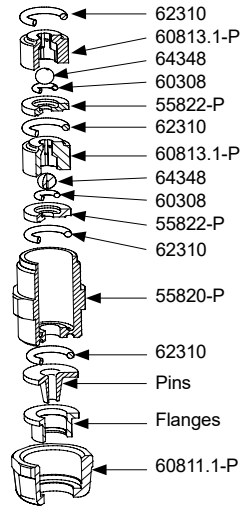
**Discharge
55-801-P**



**Suction
55-800-P**



| Pipes | 4 x 6 | 6 x 8 | 6 x 12 | 10 x 12 |
|---------|---|---|---|---------|
| Flanges |  55826-P |  60878.1-P |  60877.1-P | |
| Pins |  55825-P |  55827-P |  55829-P | |

PRIMING VALVE

55-835-P (60 l/h max.)

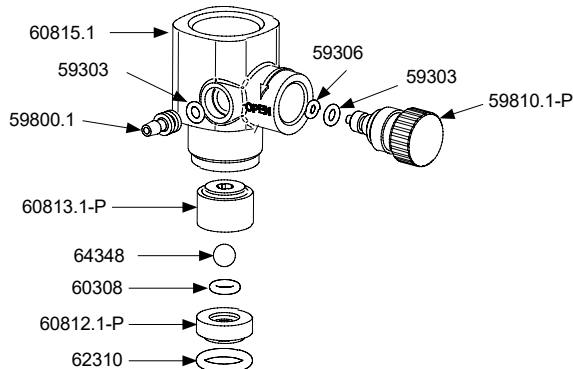



Before any maintenance operation check:

The pump is stopped and disconnected from the power supply.

There is no pressure inside the head or in the discharge pipe. It is recommended to empty the head before opening it.

Maintenance personnel should use the appropriate means of protection for handling the liquid being dosed.

PERIODIC MAINTENANCE:





Check the condition of the suction filter once a month.

Check the condition of the valves every 3 months or 1000 hours

We recommend periodically circulating clean water through the dosing pump (coinciding for example with the emptying of the tank), in order to remove any precipitated remains from inside the cylinder or in the suction and discharge pipes.

In the event of using highly corrosive liquids, it is recommended to double the frequency of the checks.

TROUBLESHOOTING: POSSIBLE CAUSE AND SOLUTION

| PROBLEM | CAUSE | SOLUTION |
|--|--|--|
| Display off | <ul style="list-style-type: none"> - No voltage - The thermomagnetic circuit breaker has tripped | <ul style="list-style-type: none"> - Check the input voltage with a voltmeter - Check for short circuit |
| Short Circuit | <ul style="list-style-type: none"> - Unstable input voltage | Install a voltage stabilizer |
|  AL-1 | <ul style="list-style-type: none"> - Bad contact in power connector - Internal short circuit - Blocking of the pump due to overpressure or mechanism fault | <ul style="list-style-type: none"> - Check the electronics power connectors - Contact ITC technical service - Check for any closed valve in the pump delivery piping - Check that the mechanism rotates freely |
| Overt Temp / Thermal Shutdown | <ul style="list-style-type: none"> - Ambient temperature higher than allowed (45 °C) | Condition the work area to ensure temperature conditions within the tolerated range |
|  AL-2 | <ul style="list-style-type: none"> - The pump is working with overpressure - Incorrectly dimensioned delivery pipe | <ul style="list-style-type: none"> - Check that the line pressure is lower than the maximum allowable pressure of the unit - Shorten the delivery pipe or increase its diameter |
| Overload | <ul style="list-style-type: none"> - The pump is working with overpressure - Incorrectly dimensioned delivery pipe - Connection fault between the motor and the electronics board | <ul style="list-style-type: none"> - Check that the line pressure is lower than the maximum allowable pressure of the unit - Shorten the delivery pipe or increase its diameter - Check the connections between motor and electronics |
|  AL-3 | | |
| Voltage out of range | <ul style="list-style-type: none"> - Supply voltage outside the allowed range | Correct the input voltage so that it is within the allowed range |
|  AL-5 | | |

| PROBLEM | CAUSE | SOLUTION |
|--|--|---|
| Motor runs but pump does not inject or dosing is lower than nominal | - Pump not primed | - Prime the pump by opening the priming valve or filling the head with the liquid to be injected |
| | - Dirty or damaged suction or delivery valve | - Clean or change valves |
| | - Dirty suction filter | - Clean filter |
| | - Air enters the suction pipe | - Check tightness of connection points |
| | - Cavitation in suction | - Increase pipe diameter. - Reduce the suction pipe length. - Reduce speed by using a variator. - Use a less viscous liquid. |
| Pump drips liquid from bottom orifice of cylinder | - Damaged diaphragm | - Change diaphragm |

WIRING

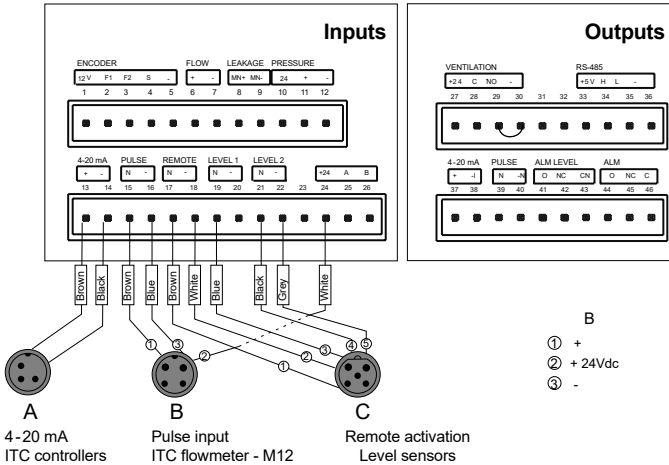
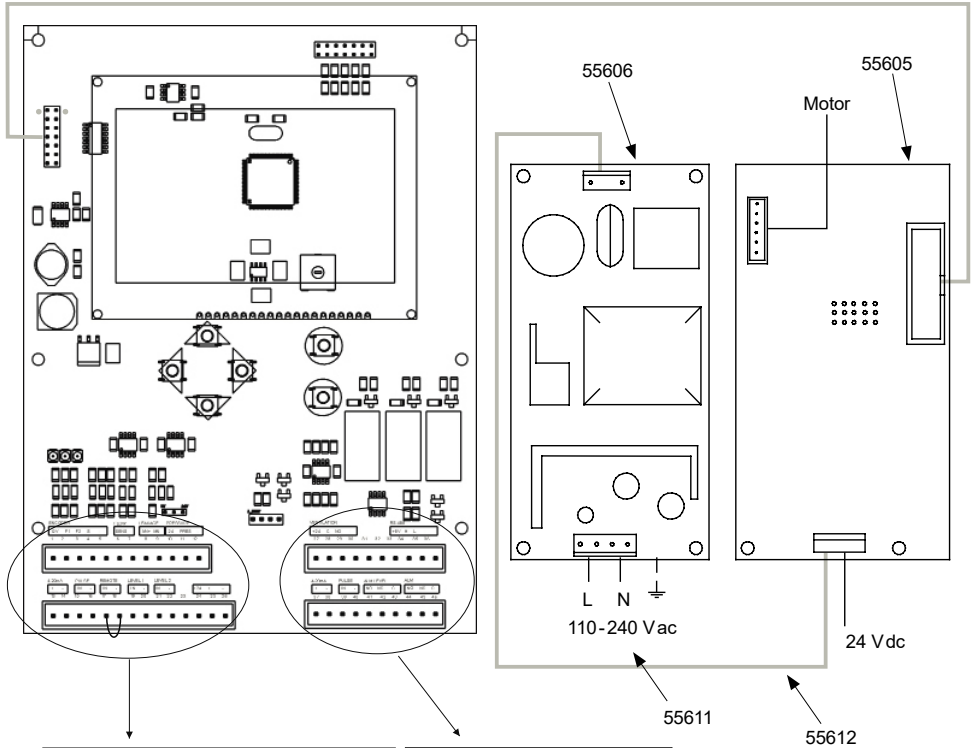

External quick connectors

CE DECLARATION OF CONFORMITY



I.T.C. S.L.
Vallès, 26
Polígono Industrial Can Bernades-Subirà
08130 Santa Perpètua de Mogoda

Declares that all models of DOSmart AC products identified with serial number and year of manufacture comply with Machinery Directive 2006/42/EC, Low Voltage Directive D2014/35/EU and Electromagnetic Compatibility Directive D2014/30/EU, provided that the installation, use and maintenance are carried out in accordance with current regulations and following the instructions in the instruction manual.

Xavier Corbella
Manager

| | | | | |
|---|--|--|--|----------------------------|
|  WARRANTY | <p>I.T.C. S.L. guarantees the product specified in this document, for a period of 1 year from the date of purchase, against all manufacturing or material defects, provided that installation, use and maintenance of the equipment are correct. The equipment must be sent, free of charge, to our workshop or I.T.C. S.L.-accredited technical service and will be returned cash on delivery. The equipment must be accompanied by the warranty document, with the purchase date and stamp of the establishment where purchased, or a photocopy of the purchase invoice.</p> | | | |
| | <table border="1"><tr><td>MODEL _____</td><td rowspan="2">Date of purchase and stamp of the establishment where purchased DATE: _____</td></tr><tr><td>SERIAL No. _____</td></tr></table> | MODEL _____ | Date of purchase and stamp of the establishment where purchased DATE: _____ | SERIAL No. _____ |
| | MODEL _____ | Date of purchase and stamp of the establishment where purchased DATE: _____ | | |
| SERIAL No. _____ | | | | |

Original Manual

Ed: 08/02/2023-EN



C/ Vallès, 26 Pol. Ind. Can Bernades - Subirà
P.O. Box 60
08130 Santa Perpètua de Mogoda
BARCELONA, SPAIN

Tel. +34 93 5443040 Fax +34 93 5443161
e-mail: itc@itc.es www.itc-dosing-pumps.com