

VERDERFLEX[®]

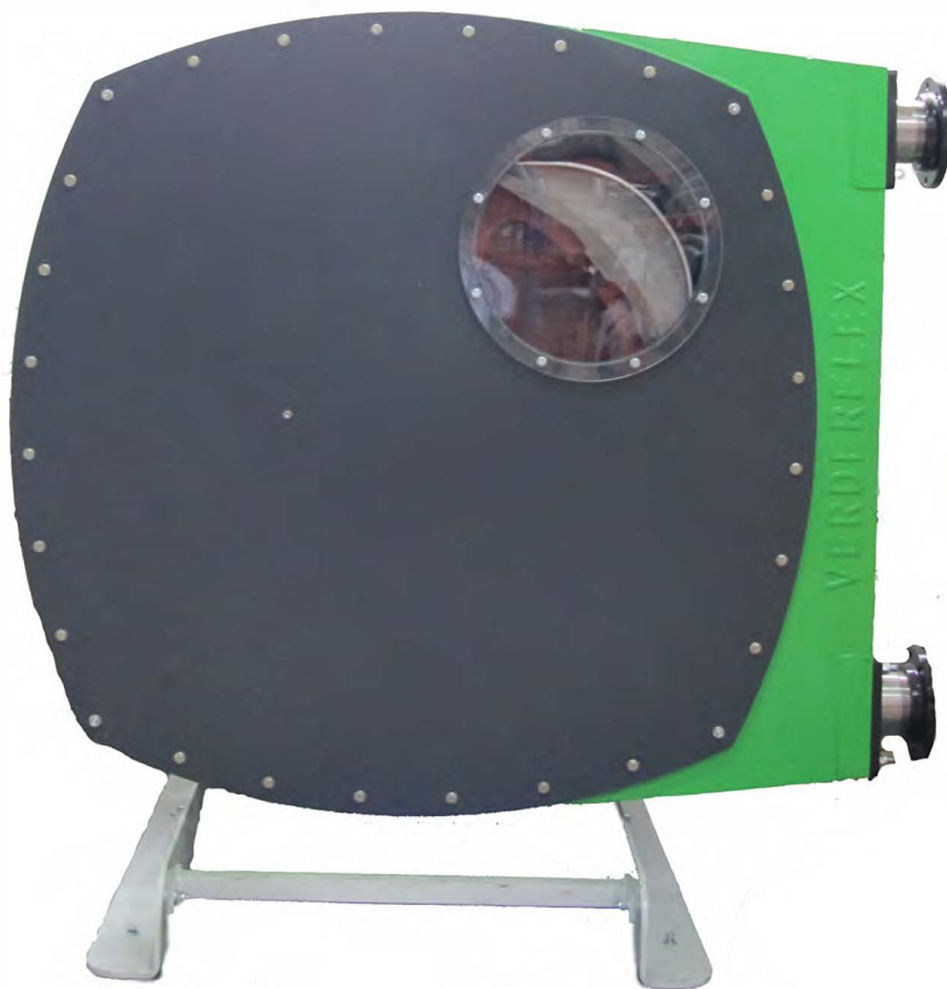

Peristaltic Hose Pumps (VF100 - VF125 Product Range)

Operations and
Maintenance Manual
Issue 4.1



VERDER 

CONTENTS

	Pages
CHAPTER 1	
Purpose and Planning Information	1.0 to 1.5
CHAPTER 2	
Operating Information/Commissioning	2.0 to 2.20
CHAPTER 3	
Technical Information	3.0 to 3.11
CHAPTER 4	
Installation and Fault Finding.....	4.0 to 4.23
CHAPTER 5	
Maintenance and Servicing	5.0 to 5.5
CHAPTER 6	
Spare Parts List	6.0 to 6.10

CHAPTER 1

PURPOSE AND PLANNING INFORMATION

CONTENTS

Para		Page
1	Disclaimer of Warranty and Limitations of Liability.....	1.0
7	Introduction	1.1
	Safety Issues	1.1
8	Warnings.....	1.1
9	Safety First.....	1.2
14	Pump Safety Features.....	1.2
16	Warranty Registration	1.3
20	Complaints procedure.....	1.3

DISCLAIMER OF WARRANTY AND LIMITATIONS OF LIABILITY

1 The VF100 and VF125 pumps are warranted against defects in workmanship and material under normal use (rental use excluded) for two years from date of purchase. This is to the extent that Verder will at its option replace, repair or refund, in full, the purchase price of the instrument of any part thereof manufactured by Verder, which in our opinion is defective. Also provided the instrument has been operated in strict accordance with this document, and has not been subjected to tampering, abuse or exposed to highly corrosive and/or unspecified explosive conditions.

2 This warranty does not cover the conditions arising as follows:

2.1 Failure of Verder manufactured parts or components including hose, due to normal wear or any damage or failure; that in Verder's judgment arises from misuse.

2.2 Failure to implement the necessary safety procedures for use in the European Community of a pump within an explosive atmosphere as laid down in latest EC Atex directive from 1st July 2003.

2.3 Failure to disclose the use of a pump (intended or unauthorized) within a known explosive atmosphere.

Verder MAKES NO WARRANTIES, EXPRESSED OR IMPLIED, INCLUDING, WITHOUT LIMITATION, ANY WARRANTIES OF FITNESS OR MERCHANTABILITY, EXCEPT AS EXPRESSLY SET FORTH ABOVE. Verder SHALL NOT BE LIABLE FOR ANY INJURIES, LOSSES OR DAMAGES INCLUDING, BUT NOT LIMITED TO ANY PERSONAL INJURIES, ANTICIPATED OR LOST PROFITS, INCIDENTAL DAMAGES, CONSEQUENTIAL DAMAGES, COSTS, TIME CHARGES, OR OTHER DAMAGES OR LOSSES, IN CONNECTION WITH THE INSTRUMENT, ITS USE OR ANY REPLACEMENT PARTS THEREFORE:

3 Full completion of the warranty card is essential in order to be covered by Verderflex outstanding warranty schemes. Please be aware of the declaration that you undertake to use only Verder spare parts - this is an essential part of the warranty scheme and is legally binding. The card will also act as a record of your dealings with Verderflex and its distributors.

4 This warranty is voided if the customer fails to follow any and all instructions, warnings or cautions in this document. Verder has made every effort to illustrate and describe the product(s) in this document. Such illustrations and descriptions are, however, for the sole purpose of identification and do not express or imply a warranty that the products are merchantable or fit for a particular purpose, or that the products will necessarily conform to the illustration or descriptions.

5 If a manufacturing defect is found, Verder will replace or repair the instrument or replace any defective part thereof without charge. However, Verder's obligation hereunder does not include the cost of transportation of the instrument to Verder or its return to the customer; these costs must be borne by the customer. Verder assumes no responsibility for damage in transit; any claims for such damage should be presented to the carrier by the purchaser.

6 In addition, instead of replacing or repairing the instrument as aforesaid, Verder may, at its sole option, take back the defective instrument and reimburse the customer for the purchase price in full settlement of any and all potential claims related to the purchase or use of the Verderflex® hose pump.

INTRODUCTION

7 The Verder Group of companies have offices located in Austria, Belgium, China, Czech Republic, France, Germany, Hungary, Japan, Norway, Poland, Romania, Slovakia, South Africa, The Netherlands, United States and the UK. A network of worldwide distributors support our products in other countries of which a full list can be seen at Verder Group headquarters are in Holland.

SAFETY ISSUES

Warnings

8 Warnings are used throughout this document. Each warning contains important safety information. Warnings are generally used for potential hazards (indicated by a black on yellow triangle) and definite hazards (white on red triangle). Below are some examples of warnings that can be found in this publication.



PERSONNEL HAZARD. Ensure that all local standing operating procedures and all current health & safety regulations are complied with, when carrying out any of the procedures documented within this publication.



HEAVY WEIGHT. The pump cover weighs 1,000kg (2,200lb). Due consideration must be given to the regulations governing the lifting of heavy weights when moving this equipment.



SAFETY HAZARD. Do not walk or work under a suspended pump cover.



LETHAL VOLTAGES. Dangerous voltages exist in this equipment. When carrying out work on any electrical equipment during failure diagnostics, refer to Chapter 4.



EQUIPMENT DAMAGE. Before test running the pump; check that all tools are removed, particularly from pump casing.

Safety First

9 The information in this document is essential for the safe operation and servicing of Verderflex® pumps. This document must be read and understood; in particular Chapter 2 for operation in normal and explosive atmospheres, before operating or servicing such pumps.

10 Appropriate local safety regulations and practices must be considered and adhered to.

11 This document is available from any Verder distributor.

12 Comments and recommendations should be submitted to Verder via your distributor.

13 Throughout this document these safety warning and cautions are repeated. The relevant information will act as a guideline for you in operating the pump; alternative courses of action are also described should you be unable for any reason to follow those procedures initially given. You are advised to follow these guidelines to achieve maximum efficiency.

Pump Safety Features

14 The Verderflex® has a number of in-built features, which have been designed specifically to ensure your safety during operation and maintenance of the unit:

14.1 Disaster proof design – the casing will contain any spillage preventing leaks and contamination of product.

14.2 Low and high level controls for automatic cut out (optional).

14.3 Use of food grade, top quality Verderlube® lubricant.

14.4 Use of taper locks for easy handling, and designed for safe and easy assembly and maintenance.

15 Safety instructions and guidance are divided into operational safety, maintenance safety and safety advice for assembly, installation and commissioning, with each category having its own rules and philosophy. This section covers operational functions that are reasonably foreseeable. Many warnings and admonitions are included in this document; unfortunately there are too many to incorporate into "on unit" labels. For this reason it is essential that the document be treated as part of the product and made mandatory reading for personnel associated with the product and system.

Warranty Registration

16 Please ensure that the distributor has the following details from your initial and any subsequent orders for pump(s)/spare(s):

- 16.1 Pump Size/ spares make and type.
- 16.2 Serial number.
- 16.3 Media to be pumped.
- 16.4 Pressure (bar/PSI).
- 16.5 Temperature of medium.
- 16.6 Capacity m³/hr or US GPM or HP and Frequency Hz
- 16.7 Suction.
- 16.8 Motor size kW or HP and Frequency Hz
- 16.9 Date of order and delivery.
- 16.10 Verder reference.

17 Please be aware of the declaration that you undertake to use only Verder spare parts - this is an essential part of the warranty scheme and is legally binding.

18 This information will similarly be required if and when you should need to order spare parts from your local Verder distributor.

19 Should you have cause to return the pump for any reason, please ensure that you inform the local distributor as fully as possible of the details of the problem; the distributor has the necessary documentation for completion of the warranty application to Verder and is aware that this has to be completed in full before Verder can examine the application

Complaints Procedure

20 Should you be dissatisfied with your Verder pump(s) or with any aspect of the service you have received, then please contact your local Verder distributor in the first instance to discuss the matter fully.

INTENTIONALLY LEFT BLANK

CHAPTER 2

OPERATING INFORMATION/COMMISSIONING

CONTENTS

Para		Page
1	General – tools and facilities	2.0
	Operational Safety (WARNINGS)	2.1
	Assembly and Preparation	2.1
4	Assembly	2.1
5	Preparation	2.1
9	Commissioning	2.2
13	Operation	2.2
15	Maintenance	2.2
16	Lubrication	2.2
20	Glossary of terms	2.6
21	Explosive proof labelling.....	2.6
	Verderlube® safety data sheet	2.7
	Verdersil safety data sheet.....	2.13
Table		
1	Normal Operation Risk & Preventative Measures.....	2.3
2	Explosive Operation Risk & Preventative Measures.....	2.4
3	Ecotoxicity classification criteria	2.17
4	EPA SARA Title III Chemical Listings.....	2.18
Fig		
1	Explosion proof labelling	2.6

General – tools and facilities

1 Care should be taken at all times to ensure that any tools are used safely for the purpose for which they are designed and in accordance with the manufacturer's instructions. Ideally the pump should be installed using a drive, with facilities to inch the pump along and which is able to operate in reverse. Any maintenance work will require a complete set of **METRIC** spanners, a socket set and torque wrench; you should check your fastener kit to ensure you have all the correct sizes available.

2 Lifting equipment will be required for several of the procedures. The lifting equipment to be used should be checked for suitability for the task and capable of lifting the combined weight of the pump components. Always follow the manufacturer's instructions for safe operation of lifting equipment.

3. Local regulations regarding health and safety must be followed.

Operational Safety

WARNINGS



LETHAL VOLTAGES. Dangerous voltages exist in this equipment. Always isolate the power supply before working on the pump.



SAFETY HAZARD. Never place hands or other parts of the body inside or near any part of the pump when it is in operation or when the power is not totally isolated.



SAFETY HAZARD. When the pump is running, you should not touch the pump and should maintain an adequate safe distance around it.



SAFETY HAZARD. Do not climb onto the pump or connecting pipe work.



SAFETY HAZARD. Maintain a clean environment around the pump. The Verder pump is manufactured from cast iron, and therefore the flanges and casings etc may have sharp edges - slipping or falling against the pump may cause serious injury.



Wear appropriate Personal Protection Equipment (PPE) when operating on or working near the pump.

Assembly and Preparation

Assembly

4 Verderflex® hose pumps are sold around the world and may be transported either as a compact flat-pack or fully assembled to the country of destination. Under normal circumstances your Verder distributor or Verderflex will assemble the pump, but should this not be the case for any reason, you should follow the following procedures:

Preparation

5 Prepare the workspace in which the pump is to be built, ensuring there is a clean and level work surface with sufficient room for not only the pump, but also to allow you sufficient access to the pump and fit pipe work, etc.

6 Carefully open the packaging and check for completeness by ensuring all the parts listed are present; remove all the loose components and set them out on a workbench. It is recommended that the fastener kit is sorted into piles of like items and kept in a safe place to avoid losing parts or using an incorrect part

7 If the pump casing or any parts are found to be damaged, the wrong type, specification or are missing; then you should record the appropriate serial number from the casing identification plate and/or the quality check seal on the packaging, and inform Verderflex.

8 To install the pump; refer to Chapter 4.

Commissioning

9 Check all fasteners are tightened to the required settings (refer to Chapter 4). Before connecting any pipe work to the pump carryout the following:

8.1 Run the pump dry for 10-20 revolutions in both directions to ensure that the hose is properly secured.

9 Connect the pipe work and torque-tighten all fasteners to the required settings.

10 Close all drainage taps and open all valves.

11 Run the pump for 10-20 revolutions; check for any leaks.

12 Test the pump for leaks at operating pressure and correct flow rate. Carry out re-adjustments as necessary.

Operation

13 The pump should only be used for the purpose it was sold. For normal continuous operation of the VF100 and VF125 pump speeds should **NOT** exceed 30rpm unless expressly advised by your Verder distributor.

14 Operating pressure should not be altered to operate outside the tolerances recommended by your Verder distributor.

Maintenance

15 It is good practice to wash down the external surfaces of the pump prior to carrying out any maintenance operations. This will prevent the interior of the pump being contaminated with dirt or debris.

Lubrication

16 The standard lubricant is Verderlube® a specially formulated food grade lubricant, which is designed to reduce the friction between hose and rotor shoe. The lubricant is food grade standard, blue in colour and can be used at temperatures ranging from -40°C up to 100°C (-40°F up to 210°F).

17 It is vital that lubricant levels are monitored at all times - an increase in levels of lubricant will indicate hose failure. If this occurs, the product will be contained within the pump housing; performance will deteriorate and eventually cause product contamination. It is recommended that a hose burst detection unit (Optional) is fitted.

TABLE 1 NORMAL OPERATION & RISK PREVENTATIVE MEASURES

18 Table 1 lists possible malfunctions of the pump and its components during normal operation; and preventative measures in place to avoid any malfunctions.

NORMAL OPERATION ASSESMENT			
Ser	Normal Operation	Malfunction	Preventative Measures
(1)	(2)	(3)	(4)
1	Hose Leaking into pump case	Hose rupture or Hose pulled out of clamp ring	Do not exceed the maximum working pressure of 16 bar/ 230 PSI. Do not work on a running pump near to filler tube/inspection window. When dismantling the pump isolate the power supply.
2	Incorrect assembly		Observe correct build procedure (refer to Chapter 4).
3	Exceeds recommended temperatures	Hose rupture causing hazardous medium to spray out	Ensure lubricant level is correct. Rotor is shimmed correctly.
4	Polypropylene insert use	Distortion at high operating temperatures	Check operational specification and use alternative stainless steel or PVDF inserts.
5	Gear motor unit spec	Does not meet Atex (Where appropriate)	Ensure that an explosion proof motor is fitted where appropriate.
6	Hazardous medium in pump case after tube burst	Personal Injury	Observe safety precautions.
7	Pump operational safety precautions	Personal Injury	Wear appropriate PPE
8	Construction materials not resistant to pumped media	Adverse chemical reaction, heat build up, personal injury.	Ensure sub components other than hose are compatible with media being pumped.
9	Verderlube® pump lubricant not resistant to pumped media	Adverse chemical reaction to glycerine based products with strong acids and oxidising agents with risk of explosion.	Ensure Verderlube® lubricant is compatible with media being pumped. Use of Verdersil may be required.

TABLE 2 EXPLOSIVE OPERATION & RISK PREVENTATIVE MEASURES

19 Table 2 lists possible malfunctions of the pump and its components during explosive operation; and preventative measures in place to avoid any malfunctions.

EXPLOSIVE OPERATION ASSESMENT				
Ser	Normal Operation	Malfunction	Preventative Measures	Ignition Protection
(1)	(2)	(3)	(4)	(5)
1	Frictional heat of moving parts inside the gearbox		The moving parts inside the gearbox are submersed in oil/grease which acts as a lubricant, spark quenching agent & coolant.	Liquid immersion `K`
		Unacceptable loss of oil from gearbox	A level plug is provided on the gearbox. The oil level has to be checked for low level and signs of contamination.	Instruction Manual
2	Guarding	Mechanical contact	Ensure secure and aligned correctly, use brass plate.	Non sparking + Instruction manual
		Dust deposits on gearbox	Guarding or regular cleaning is needed to prevent deposits deeper than 5mm accumulating.	Instruction Manual
3	Static Discharge	Hose Failure	The hose inside the casing is covered and / or submersed in lubricant, a spark quenching agent and coolant.	Liquid Immersion `K`
		Liquid transfer through pump outlets	Metal parts are supplementary bonded to provide an electrically conductive path less 100 Ohm. This also is particular to pvdf & polypropylene inserts.	National standards for electrostatic requirements plus user instruction.
		Rubbing/cleaning of plastic inspection window	Supplementary bonding may be required, also clean in place where possible using non nylon cloth.	National standards for electrostatic use+ manual. Discharge of component before refit if removed for cleaning.

(continued)

TABLE 2 EXPLOSIVE OPERATION & RISK PREVENTATIVE MEASURES (continued)

EXPLOSIVE OPERATION ASSESSMENT				
Ser	Normal Operation	Malfunction	Preventative Measures	Ignition Protection
(1)	(2)	(3)	(4)	(5)
		Overfilling & discharge of pump media through filler tube	Earth clamp can be fitted or an optional level sensor fitted. Alternatively an optional burst pressure sensor can be fitted both of which shut down the drive motor.	Instruction Manual. Control of ignition source `B` if second option fitted
4	Pump operation in an explosive atmosphere	H&S in an explosive environment	Ensure during pump operation a warning triangle with black letters `Ex` on a yellow background is displayed at points on entry to work area.	EN 13463-1
5	Frictional heat of moving parts inside the casing	Risk of sparking	The moving parts inside the casing are covered and / or submersed in lubricant, a spark quenching agent and coolant.	Liquid Immersion `K`
		Unacceptable loss of lubricant from casing through leaks or suction	A level plug is/can be provided on the front cover. The oil level and sealing joints have to be checked weekly. Alternatively, a low level sensor can be fitted and set BELOW normal operating level, taking into account level fluctuations.	Instruction manual or control of ignition source `B` if monitoring is fitted
6	Front Cover	High surface temperature	As above plus ensure shimming is correct and pump does not run dry for long periods.	
7	Change in duty by reduction of rpm	Over Temp	Re specify drive	Contact drive manufacturer To control ignition source
8	Optional Hose burst pressure sensor	Explosion risk from spark	Standard VFOC5 sensor must not be used for explosive operation. An alternative Exd / EExd component should be used.	Instruction manual plus control of ignition source `B` if option used
9	Closed liquid internal circuit	Excess temperature	Fit temp probe to front cover or continuous temp. monitoring can be fitted and set to trip the drive power at 10°C/20°F above normal running temp.	Instruction manual and control of ignition source `B` if monitoring is fitted
10	Closed valve condition	Excess temperature and pressure	Carry out routine maintenance checks to ensure controlled temp & gauge pressures.	Instruction manual

Glossary of terms

20 Below is a glossary of terms for table 3.

Safety `C`	Refers to the integral from standard constructional design
Ignition source `B`	Refers to protection incorporated to control an ignition source
Liquid Immersion `K`	Refers to protection of ignition due to use of spark quenching agent
Eexd/Exd	Refers to explosion proof electrical components with flameproof protection
EN 13463-1	European norm standards for Non Electrical equipment in explosive atmospheres

Explosion proof labelling

21 Fig 1 is an example of explosion proof labelling and is only fitted onto pumps supplied as ATEX compliant at the time of order.

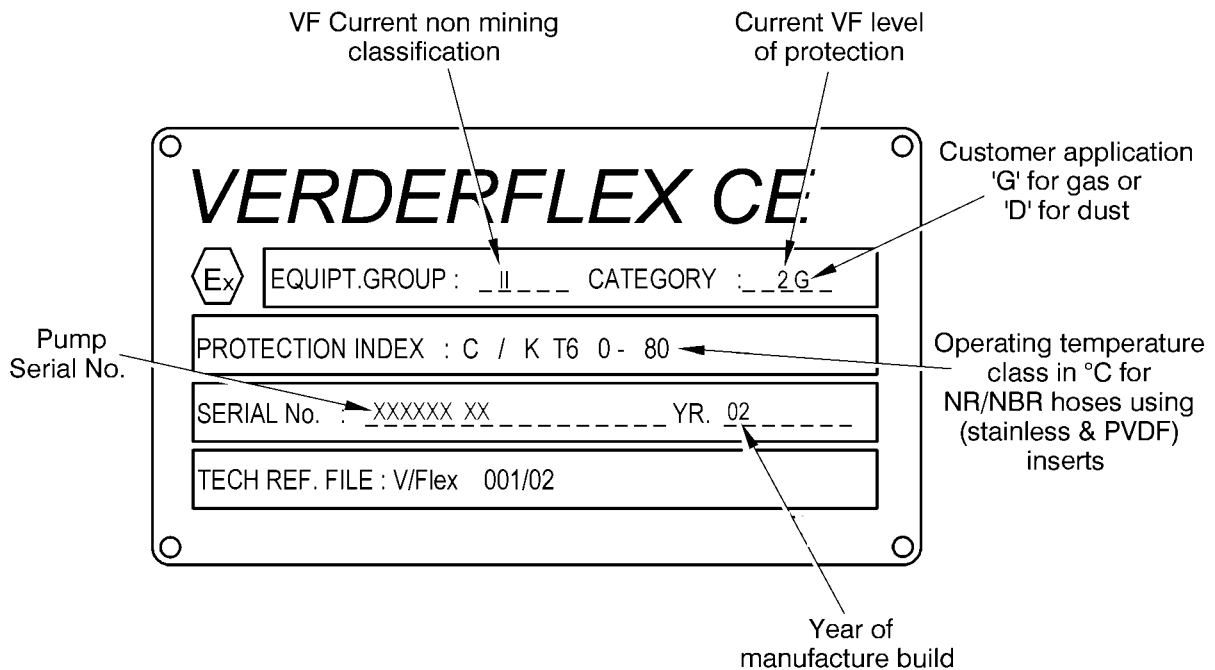

VER/087

Fig 1 Explosion proof labelling

VERDERLUBE® SAFETY DATA SHEET

IDENTIFICATION OF THE SUBSTANCE/PREPARATION AND OF THE COMPANY/UNDERTAKING

Identification of Substance or Preparation

Product Name	Verderlube®
Chemical Identification	Glycerine based blend
CAS number	Preparation
Use	Food grade – pump lubricant/coolant

Company Identification

Producer/Supplier	VERDER LIMITED Unit 3 California Drive Castleford WF10 5QH Great Britain
Tel number	+44 (0) 1924 221 020
Fax number	+44 (0) 113 246 5649
Emergency telephone number	
For advice on this product call:	+44 (0) 1924 221 020

COMPOSITION/INFORMATION ON INGREDIENTS

This product contains no substances classified as hazardous to health in concentrations that should be taken into account according to EC directive 91/155/EC.

- Main constituent may cause irritation to eyes and skin.
- Irritating to respiratory system in the form of a mist.

HAZARDOUS IDENTIFICATION

This product is not classified as hazardous according to EC directive 91/155/EC.

- May cause irritation to eyes and skin.
- Irritating to respiratory system in the form of a mist.
- Contact with hot product may cause burns.
- Product is a lubricant and in the event of untreated spillage, can cause external surfaces to become slippery when wet

FIRST AID MEASURES

Used lubricant may become contaminated with pumped product, also verify precautions and advice against relevant product information.

Ingestion

Except as a deliberate act, the ingestion of large amounts of product is unlikely. If this should occur, do not induce vomiting, obtain medical advice.

- If ingested give 500 ml of Water to drink.

Inhalation

If inhalation of fumes from overheated material causes irritation to the nose or throat, or coughing, remove to fresh air. Obtain medical advice if any symptoms persist.

Skin Contact

No first aid should be required but should any symptoms persist, seek medical advice. If contact with skin occurs:

- Wash thoroughly with mild soap and water as soon as reasonably practical.
- Remove heavily contaminated clothing and wash underlying skin.

Eye Contact

Direct contact may cause temporary redness and discomfort. Wash eye thoroughly with copious amounts of water, ensuring eyelids are held open. Obtain medical advice if any pain or redness develops or persists.

FIRE FIGHTING MEASURES**Extinguishing Media**

The best type of fire fighting media to use is:

- Alcohol resistant foam.
- Dry powder.
- Water fog.

Extinguishing Media to avoid

Do **NOT** use water jets.

Unusual Fire and Explosion Hazards

Avoid spraying directly into storage containers due to a danger of boil over.

Special Protective Equipment for Fire fighters

Wear protective clothing and approved breathing apparatus when in close proximity of fire.

Poisonous Acrolein may be found during burning.

Accidental Release measures

Used lubricant may become contaminated with pumped product, also verify precautions and advice against relevant appropriate product information

Personal Protection

Wear goggles and gloves. If spillage has occurred in a confined space, ensure sufficient ventilation and check that a safe, breathable atmosphere is present before entry.

Environmental precautions

Protect drains from spills and prevent entry of product. Treated effluent may be biodegradable. Recover cleaning water for later treatment.

Methods for cleaning up

Contain and recover liquid, soak up with absorbent material (sand, peat, etc.) or contain and shovel into drums or containers. Remove residue by spraying with water.

HANDLING AND STORAGE

Handling

Contact with hot product causes burns.

- Avoid contact with eyes. If splashing is likely to occur wear a full visor or chemical goggles to appropriate local national standards.
- Avoid frequent or prolonged skin contact with fresh or used product.
- Wash hands thoroughly after use.

Storage

Store under cover; away from moisture and sources of ignition. Do not overheat in storage.

The lubricant/coolant is hygroscopic; keep the container tightly closed.

EXPOSURE CONTROLS/PERSONAL PROTECTION

Personal Protection

Hand Protection:

- PVC or Rubber Gloves

Eye Protection:

- Chemical goggles

Respiratory protection is unnecessary, providing concentration of vapour, mists or fumes is adequately controlled.

Occupational exposure limits

- Ensure good ventilation.
- Threshold limit Not tested

PHYSICAL AND CHEMICAL PROPERTIES

FORM	Viscous liquid
COLOUR	Blue. Colourless may be supplied to special order
ODOUR	Odourless
SOLIDIFICATION POINT	-40°C/-40°F approx.
FLASH POINT	177°C/350°F approx. (COC: ISO 2592)
BOILING POINT	290°C/554°F
SOLUBILITY IN WATER	Miscible (at 20°C)
VAPOUR PRESSURE	(20°C/68°F) <0.01 mbar (100°C/210°F) <1 mbar
VISCOCITY	700 mPaS approx. @ 20°C/68°F
pH	7 approx.

(continued)

PHYSICAL AND CHEMICAL PROPERTIES (Continued)

AUTO IGNITION TEMPERATURE	400°C / 750°F approx.
EXPLOSION LIMITS	Not established
DENSITY (20°C/68°F)	1245 kg/m ³ approx.
BEHAVIOUR WITH WATER AT 20°C Hygroscopic	

STABILITY AND REACTIVITY**Conditions to avoid**

Preparation is stable and unlikely to react in a hazardous manner under normal conditions of use.

No special precautions other than good housekeeping of chemicals.

Hazardous polymerization reactions are unlikely to occur.

This material is combustible.

Materials to avoid

Avoid contact with strong oxidizing agents, nitrogenous compounds and strong acids: risk of violent and or explosive reactions with pure compounds.

Hazardous decomposition products

During burning, poisonous acrolein may be found – very toxic by inhalation.

Incomplete combustion / thermal decomposition will generate smoke, carbon dioxide and hazardous gases, including carbon monoxide.

TOXICOLOGICAL INFORMATION**Toxicity Data**

General purpose food grade lubricant/coolant.

LD50 oral (rat) 12600 mg/kg (not harmful) *

Significant data with possible relevance to human health

Eyes Unlikely to cause more than transient stinging or redness (if accidental eye contact occurs).

Skin Unlikely to cause harm to the skin

Ingestion Unlikely to cause harm if accidentally swallowed in small doses, although larger quantities should be avoided

Inhalation At ambient temperatures this product will be unlikely to present an inhalation hazard

ECOLOGICAL INFORMATION**Mobility**

Spillage may penetrate the soil; unused preparation is food grade and is inherently harmless.

Persistence and Degradability

This preparation is inherently biodegradable.

Bio Accumulative Potential

There is no evidence to suggest that bioaccumulation will occur.

Aquatic Toxicity

Verderlube® is miscible in water. It is not considered harmful in low concentrations.

Water pollution reactors	gO ₂ /g
BOD ⁵ :	0,87 (NEN 3235-5.4)
BOD ¹ :	1.16 (NEN 3235-5.3)
Fish: goldfish	LC50 (24h):>5000 mg/l (modified ASTM D1345)

The aquatic toxicity (TLm96) is >1000mg/1, which is defined by NIOSH as an insignificant hazard

DISPOSAL CONSIDERATIONS

Waste Disposal Method(s)

- Where possible, arrange for unused product to be recycled.
- Disposal of preparation should be via an authorized person/licensed waste disposal contractor in accordance with local regulations.
- Incineration may be carried out under controlled conditions provided that local regulations are met.
- Dispose of preparation and container carefully and responsibly. Do not dispose of preparation near ponds, ditches, down drains onto soil.

TRANSPORT INFORMATION

Not classified as dangerous for transport (RID/ADR-ADNE-IATA-IMDG-MARPOL-ICAO).

Other Information

Employees of the Verder group have not experienced any harmful effect during normal handling and production.

Verderlube® and Verderflex® are registered trademarks.

*The information contained in this sheet is based on our knowledge of the preparation at its delivery date and that the information contained herein is current as of the date of this data sheet. Since the use of this information and of these opinions and the conditions of use of this preparation is not within the control of Verderflex, it is the user's obligation to determine the conditions of safe use of the preparation. The information contained in this sheet is based on our knowledge of the product at its delivery date.



REACH LEGISLATION COMPLIANCE – CUSTOMER STATEMENT

REACH stands for Registration, Evaluation, Authorisation & Restriction of Chemicals.

The REACH regulations have been adopted by the European Parliament and came into force on the 1st June 2007. They provide a comprehensive reform of the regulations surrounding the manufacture, marketing, import and use of chemical substances in the European Union.

The main objectives of the regulations are to ensure that chemical substances used within the EU are properly assessed for their safety to both humans and the environment and where appropriate the use of some substances may be restricted or prohibited.

All chemicals manufactured or imported into Europe in quantities greater than 1 tonne are affected.

Initially, all manufacturers and importers had to pre-register their chemicals under REACH with the ECHA (European Chemicals Agency) in Helsinki and this had to be completed by December 2008. According to the legislation, if a chemical wasn't pre-registered by this time, it could no longer be sold within the EU.

Verderflex manufacture peristaltic pumps, all components of which are considered Articles within the REACH regulations with the exception of the lubricants VERDERLUBE and VERDERSIL.

We pre-registered VERDERLUBE & VERDERSIL on 30/11/2008, our pre-registration identifier being XY 651413-97

The next and current stage is the actual registration process which involves providing a package of technical information on the chemical and its hazards.

Article 57 of the REACH regulation lays out the criteria that causes a substance to be required to be registered and included in Annex XIV as a Substance of Very High Concern (SVHC) and to be either restricted, prohibited or requiring authority to be used and the conditions therewith.

Verderflex have confirmation from our supply chain that all products that have needed to be pre-registered have been and that VERDERLUBE and VERDERSIL are not considered restricted chemicals requiring registration under Article 57 of the REACH regulations.

Verderflex issue Material Safety Data Sheets for VERDERLUBE and VERDERSIL which are downloadable from our website.

Verderflex take our responsibilities seriously in respect of the REACH regulations and we monitor ECHA press releases to ensure that we continue to operate within the regulatory guidelines.

In the extremely unlikely event that VERDERLUBE or VERDERSIL, or their components, fall under Article 57 of REACH, Verderflex will be proactive in advising all customers of the change of status and this statement will be refreshed accordingly.

Kenneth McCartney – Verderflex Managing Director

A handwritten signature in black ink that reads "Kenneth McCartney 15 July 2010". The signature is written over a horizontal line.

VERDERSIL SAFETY DATA SHEET

IDENTIFICATION OF THE SUBSTANCE/PREPARATION AND OF THE COMPANY/UNDERTAKING

Identification of Substance or Preparation

Product Name	Verdersil
Chemical Identification	Silicone fluid (Polydimethyl siloxane 350 CPS)
CAS number	Preparation
Use	Pump lubricant/coolant

Company Identification

Producer/Supplier	VERDER LIMITED Unit 3 California Drive Castleford WF10 5QH Great Britain
Tel number	+44 (0) 1924 221 020
Fax number	+44 (0) 113 246 5649
Emergency telephone number	
For advice on this product call:	+44 (0) 1924 221 020

COMPOSITION/INFORMATION ON INGREDIENTS

This product contains no substances classified as hazardous to health in concentrations that should be taken into account according to EC directive 91/155/EC.

- Main constituent may cause irritation to eyes and skin.
- Irritating to respiratory system in the form of a mist.

HAZARDOUS IDENTIFICATION

This product is not classified as hazardous according to EC directive 91/155/EC.

- May cause irritation to eyes and skin.
- Irritating to respiratory system in the form of a mist.
- Contact with hot product may cause burns.
- Product is a lubricant and in the event of untreated spillage, can cause external surfaces to become slippery when wet

FIRST AID MEASURES

Used lubricant may become contaminated with pumped product, also verify precautions and advice against relevant product information.

Ingestion

No first aid should be required but should any symptoms persist, seek medical advice.

Inhalation

No first aid should be required but should any symptoms persist, seek medical advice.

Skin contact

No first aid should be required but should any symptoms persist, seek medical advice. If contact with skin occurs:

- Wash thoroughly with mild soap and water as soon as reasonably practical.
- Remove heavily contaminated clothing and wash underlying skin.

Eye contact

Direct contact may cause temporary redness and discomfort. Wash eye thoroughly with copious amounts of water, ensuring eyelids are held open. Obtain medical advice if any pain or redness develops or persists.

FIRE FIGHTING MEASURES

Extinguishing Media

The best type of fire fighting media to use is:

- Alcohol resistant foam.
- Dry powder.
- Water can be used to cool fire exposed containers.

Extinguishing Media to avoid

None known.

Unusual Fire and Explosion Hazards

None known.

Special Protective Equipment for Fire fighters

A self-contained respirator and protective clothing should be worn. Keep containers cool with water spray until well after the fire is out. Determine the need to evacuate or isolate any area in accordance with local emergency plans.

Hazardous combustion products include Silica, Carbon Oxides and traces of incompletely burned carbon compounds may form. Formaldehyde may also be found.

National Fire Protection Association (NFPA) Profile

Health: 0

Flammability: 1

Instability/reactivity: 0

ACCIDENTAL RELEASE MEASURES

Personal Protection

Wear goggles and gloves. If spillage has occurred in a confined space, ensure sufficient ventilation and check that a safe, breathable atmosphere is present before entry.

Environmental Precautions

Prevent from spreading or entering drains, ditches or rivers by using sand, earth or other appropriate barriers

Methods for Cleaning Up

Determine the need to evacuate or isolate the area in accordance with local emergency plan. Very large spills should be contained by bunding or similar methods. Contain and recover the liquid, soak up with absorbent material (sand, peat, etc.) or contain and shovel into drums or containers.

Caution : Spilled product will produce an extremely slippery surface.

Handling and Storage

Handling

Contact with hot product causes burns.

- Avoid contact with eyes. If splashing is likely to occur wear a full visor or chemical goggles to appropriate local national standards.
- Avoid frequent or prolonged skin contact with fresh or used product.
- Wash hands thoroughly after use.

Storage

Store under cover away from moisture and sources of ignition. Do not overheat in storage.

EXPOSURE CONTROLS / PERSONAL PROTECTION

None of the components have assigned exposure limits.

Personal Protection

- Hand Protection PVC or Rubber Gloves
- Eye Protection Safety glasses should be worn

Respiratory Protection Respiratory protection is unnecessary, providing concentration of vapour, mists or fumes is adequately controlled.

Occupational Exposure Limits

- Ensure good ventilation.
- No known assigned exposure limits.

Additional Information

These precautions are for room temperature handling

Use at elevated temperatures may require additional precautions

PHYSICAL AND CHEMICAL PROPERTIES

FORM	Viscous liquid
COLOUR	Colourless
ODOUR	Odourless
SOLIDIFICATION POINT	-45°C/-60°F approx.
FLASH POINT	121°C/250°F approx. (Closed cup)
BOILING POINT	>200°C/>390°F

PHYSICAL AND CHEMICAL PROPERTIES (CONTINUED)

SOLUBILITY IN WATER	0 g/litre at 20°C
VISCOCITY	350 mPaS approx. @ 20°C/68°F
pH	7 approx.
AUTO IGNITION TEMPERATURE	>200°C / >390°F approx.
EXPLOSION LIMITS	Not explosive
DENSITY (20°C/68°F)	970 kg/m ³ approx.

STABILITY AND REACTIVITY

Conditions to avoid

Preparation is stable and unlikely to react in a hazardous manner under normal conditions of use.

No special precautions other than good housekeeping of chemicals.

Materials to avoid

Can react with strong oxidizing agents.

Hazardous Decomposition Products

Hazardous decomposition products including Formaldehyde and Silica can be formed, refer to Toxicology Information, section.

TOXICOLOGICAL INFORMATION

Toxicity Data

General non toxic lubricant/coolant.

Other than temporary discomfort on contact with the eyes, no adverse effects are normally expected.

Significant data with possible relevance to human health

Eyes Unlikely to cause more than transient stinging or redness (if accidental eye contact occurs).

Skin Unlikely to cause harm to the skin

Ingestion Unlikely to cause harm if accidentally swallowed in small doses, although larger quantities should be avoided

Inhalation At ambient temperatures this product will be unlikely to present an inhalation hazard

Product may emit Formaldehyde vapours at temperatures above 150°C/302°F in the presence of air. Formaldehyde vapour is harmful by inhalation and irritating to the eyes and respiratory system at breathing concentrations of less than 1 part per million (ppm).

ECOLOGICAL INFORMATION

Environmental Fate and Distribution

Air

This product is a high molecular weight liquid polymer, which has a very low vapour pressure (<1 mm Hg). As a result it is unlikely to become an atmospheric contaminant unless generated as an aerosol.

Water

This product has very low water solubility (< 100 ppb). As it has a specific gravity of < 1, if discharged to water, it will initially form a surface film. As the product is non-volatile and has a high binding affinity for particulate matter, it will adsorb to particulates and sediment out.

Soil

If discharged to surface water, this product will bind to sediment. If discharged in effluent to a waste water treatment plant, the product is removed from the aqueous phase by binding to sewage sludge. If the sewage sludge is subsequently spread on soil, the silicone product is expected to degrade.

Degradation

This product, polydimethylsiloxane, degrades in soil abiotically to form smaller molecules. These in turn are either biodegraded in soil or volatilized into the air where they are broken down in the presence of sunlight. Under appropriate conditions, the ultimate degradation products are inorganic silica, carbon dioxide and water vapour. Due to the very low water solubility of this product, standard OECD protocols for ready and inherent biodegradability are not suitable for measuring the biodegradability of this product. The product is removed >80% during the sewage treatment process.

Environmental effects

Toxicity to Water Organisms:

Based on analogy to similar materials this product is expected to exhibit low toxicity to aquatic organisms.

Toxicity to Soil Organisms:

Experiments show that when sewage sludge containing polydimethylsiloxane is added to soil, it has no effect on soil micro-organisms, earthworms or subsequent crops grown in the soil.

Bioaccumulative

This product is a liquid and is a high molecular weight polymer. Due to its physical size it is unable to pass through, or be absorbed by biological membranes. This has been confirmed by testing or analogy with similar products.

Fate and Effects in Waste Water Treatment Plants

This product or similar products have been shown to be non-toxic to sewage sludge bacteria.

TABLE 3 ECOTOXICITY CLASSIFICATION CRITERIA

Hazard Parameters (LC50 or EC50)	High	Medium	Low
Acute Aquatic Toxicity (mg/L)	<=1	>1and<=100	>100
Acute Terrestrial Toxicity	<=100	>100and<=2000	>2000

This table is adapted from "Environmental Toxicology and Risk Assessment", ASTM STP 1179, p.34, 1993. This table can be used to classify the ecotoxicity of this product when ecotoxicity data is listed above. Please read the other information presented in the section concerning the overall ecological safety of this material.

Disposal Considerations

Used lubricant may become contaminated with pumped product, also verify precautions and advice against relevant product information.

Waste Disposal Method(s)

Where possible, arrange for unused product to be recycled.

RCSA Hazard Class (40 CFR 261)

When a decision is made to discard this material, as received, is it classified as a hazardous waste? – No
State or local laws may impose additional regulatory requirements regarding disposal.

Transport Information

Not classified as dangerous for transport (RID/ADR-ADNE-IATA-IMDG-MARPOL-ICAO).
DOT Road Shipment Information (49 CFR 172.101) – Not subject to DOT.

Regulatory Information

Labelling according to EEC Directive – No special packaging or labelling requirements
National legislation/regulations Ozone depleting chemicals – No ozone depleting chemicals are present or used in manufacture

Status

EINECS: All ingredients listed or exempt.

TSCA: All chemical substances in this material are included on or exempted from listing on the TSCA Inventory of Chemical substances.

OSHA Hazard Regulatory Information to Standard CFR29 1910.1200

Contents of this MSDS comply with the OSHA Hazard Communication Standard 29 CFR 1910.1200.
TSCA Status: All chemical substances in this material are included on or exempted from listing on the TSCA Inventory of Chemical Substances.

TSCA Status

All chemical substances in this material are included on or exempted from listing on the TSCA.

TABLE 4 EPA SARA TITLE III CHEMICAL LISTINGS

SER (1)	SECTION (2)	HAZARD (3)
1	Section 302 extremely hazardous substances	None
2	Section 304 CERCLA hazardous substances	None
3	Section 312 hazard class: Acute: Chronic Fire Pressure Reactive	No No No No No
4	Section 313 toxic chemicals	None present or none present in regulated quantities

Supplemental State Compliance Information for California

Warning: This product contains the following chemical(s) listed by the State of California under the Safe Drinking Water and Toxic Enforcement Act of 1986 (Proposition 65) as being known to cause cancer, birth defects or other reproductive harm.

None known.

Supplemental State Compliance Information for Massachusetts

No ingredient regulated by MA Right-to-Know Law present.

Supplemental State Compliance Information for New Jersey

<i>CAS Number</i>	<i>Wt%</i>	<i>Component Name</i>
63148-62-9	>60.0	Polydimethylsiloxane

Supplemental State Compliance Information for Pennsylvania

<i>CAS Number</i>	<i>Wt %</i>	<i>Component Name</i>
63148-62-9	>60.0	Polydimethylsiloxane

Other Information

Employees of the Verder group have not experienced any harmful effect during normal handling and production.

Verdersil and Verderflex® are registered trademarks.

*The information contained in this sheet is based on our knowledge of the preparation at its delivery date and that the information contained herein is current as of the date of this data sheet. Since the use of this information, of opinions and the conditions of use of this preparation is not within the control of Verderflex, it is the user's obligation to determine the conditions of safe use of the preparation.

The information contained in this sheet is based on our knowledge of the product at its delivery date.

INTENTIONALLY LEFT BLANK

CHAPTER 3
TECHNICAL INFORMATION
CONTENTS

Para		Page
	Theory of the Pump	3.0
1	Working Principles.....	3.0
2	Features of a Hose Pump.....	3.1
3	Advantages of Verderflex®.....	3.1
5	Product Range	3.2
7	Pump Construction.....	3.2
9	MKIII Close coupled design.....	3.2
10	Verderflex® Hose	3.2
11	Limitations of the Pump	3.4
13	Pump Selection	3.4
15	Drive Selection	3.5
16	Accessories and Options	3.5
17	Pulsation Dampener	3.5
20	Hose Failure Detection	3.5
22	VFOCS Hose Burst Switch.....	3.6
23	Rpm sensor.....	3.6
25	Piping Guidelines	3.7
Table		
1	Pump sizes & weights	3.2
2	Drive selection torque range	3.5
3	PCD recommended offsets	3.7
Fig		
1	VF125 Pump unit (front view).....	3.3
2	VF125 Pump unit (rear view)	3.3
3	RPM Sensor Installation.....	3.6
4	VF100 Performance and Shimming curves (metric).....	3.8
5	VF100 General Arrangement Layout (metric).....	3.9
6	VF125 Performance and Shimming curves (metric).....	3.10
7	VF125 General Arrangement Layout (metric).....	3.11

THEORY OF THE PUMP
Working Principles

1 The pump is simple by design in its construction and operation. The medium to be pumped does not come into contact with any moving parts and is totally contained within a robust, heavy-duty hose, which consists of an inner layer, two to six reinforcement layers and an outer layer. A rotating shoe passes along the length of the hose, compressing it totally closed. This motion forces the contents of the hose directly in front of the rotating shoe to move forward along the length of the hose in a 'positive displacement', peristaltic movement. In the wake of the shoe's compressing action, the natural elasticity of the nylon reinforced rubber forces the hose to open and regain its round profile, creating suction pressure, which recharges the pump.

Features of a Hose Pump

- 2 The pump has many features:
 - 2.1 Dry running - the pump will run dry without damage.
 - 2.2 The hose effectively forms an integral part of the suction & discharge lines, connected externally by flange or hose-tail connectors ensuring zero leakage.
 - 2.3 Self priming - the pump will prime itself to 95% vacuum (equivalent to a suction lift of 9.5m of water).
 - 2.4 High solids content handling - the pump is capable of handling media with a high proportion of solids and with large particle sizes.
 - 2.5 Viscous liquids - pumps are capable of dealing with fluids up to 47,000 mPas (cPs).
 - 2.6 High differential pressures: the pump is capable of continuously running at pressures up to 16 bar (220 PSI).
 - 2.7 Few moving parts - there are no valves or joints, reducing the possibility of malfunction.
 - 2.8 Low maintenance - the main wearing part in the pump is the hose, which can be replaced quickly, easily and inexpensively.
 - 2.9 Low shearing - delicate media can be pumped effectively with little or no damage.
 - 2.10 No moving parts in the liquid stream.

Advantages of Verderflex®

- 3 The Verderflex® pump has many advantages:
 - 3.1 Compact, close coupled design.
 - 3.2 Rigid housing design for heat dissipation and accurate hose compression.
 - 3.3 Filler tube on rear of housing to prevent damage.
 - 3.4 Taper lock bush in rotor enables various gearbox / motor drives to be fitted.
 - 3.5 Hose construction provides for more efficient lubrication and longer life.
 - 3.6 Conforms to and is certified to European Hygienic Engineering & Design Group (EHEDG) Standards and so can be used within the food & drinks industry, pharmaceutical industry and other hygienic related applications not related to the end product.
- 4 The pump has the following features in addition to the ones already mentioned which are applicable for use within these industries:
 - 4.1 No moving parts in contact with the product.
 - 4.2 Hygienic Stainless Steel Port Flanges & integral hose inserts certified to EHEDG standards.
 - 4.3 Meets the EHEDG specifications for CIP (Clean In Place) pumps. This means it can be cleaned without having to dismantle it.
 - 4.4 Food grade hose.

Product Range

5 The Verderflex® pumps are sized and named according to the internal bore diameter of the hose. The range starts with the 10mm diameter VF10 unit, and incorporates a total of 10 models, up to the 125mm diameter VF125 (please note that this instruction refers to the VF100 - VF125 range only).

6 All pumps are capable of operating up to 16 bar (232 PSI) with a pumping capacity of up to 90 m³/hr / 396 GPM continuous use (for a single unit).

TABLE 1 PUMP SIZES & WEIGHTS

Ser (1)	Pump Size (2)	Weight CC (kg) (5)	Built Weight CC (kg) (4)
1	VF100	1700	2350
2	VF125	2500	3150

Pump Construction

7 Refer to Figs 1 and 2. The Verderflex® pump unit is one of the most simple, yet most robust designs of its type, with very few actual moving parts:

8 The pump housing is terminated with screw on DIN/PN 16 flanged connections (special order ANSI/JIS). Within the housing is a rotor and two rotor shoes. This assembly is rotated, causing the shoes to compress the reinforced hose, which displaces liquid to generate the pumping action. The housing provides support for the hose whilst under compression from the shoe / rotor assembly. A flange/insert mechanism is used to retain the hose position within the housing. The flange uses a split collet design to clamp and seal the hose in the casing. The rotor runs in a lubricant bath, which is filled either through the inspection cover or via a pipe at the rear of the housing. Overall the unit is designed to enable simple assembly and maintenance.

MKIII Close coupled design

9 The gearbox/motor unit is directly attached to, and supported by, a flange mounting at the rear of the housing which is configured to take a 310 series Bonfiglioli gearbox (Fig 2). The rotor and shoe assembly is fastened to the gearbox output shaft via a taper lock bush (Fig 1).

Verderflex® Hose

10 To complement the hose pump, Verder has developed the Verderflex® hose for continuous operation. Tests have shown that these hoses have significantly greater serviceable life in comparison to materials used in competitors' hoses, and are able to achieve a 95% vacuum (equivalent to a suction lift of 9.5m Wc).



VER/001

Fig 1 VF125 Pump unit (front view)

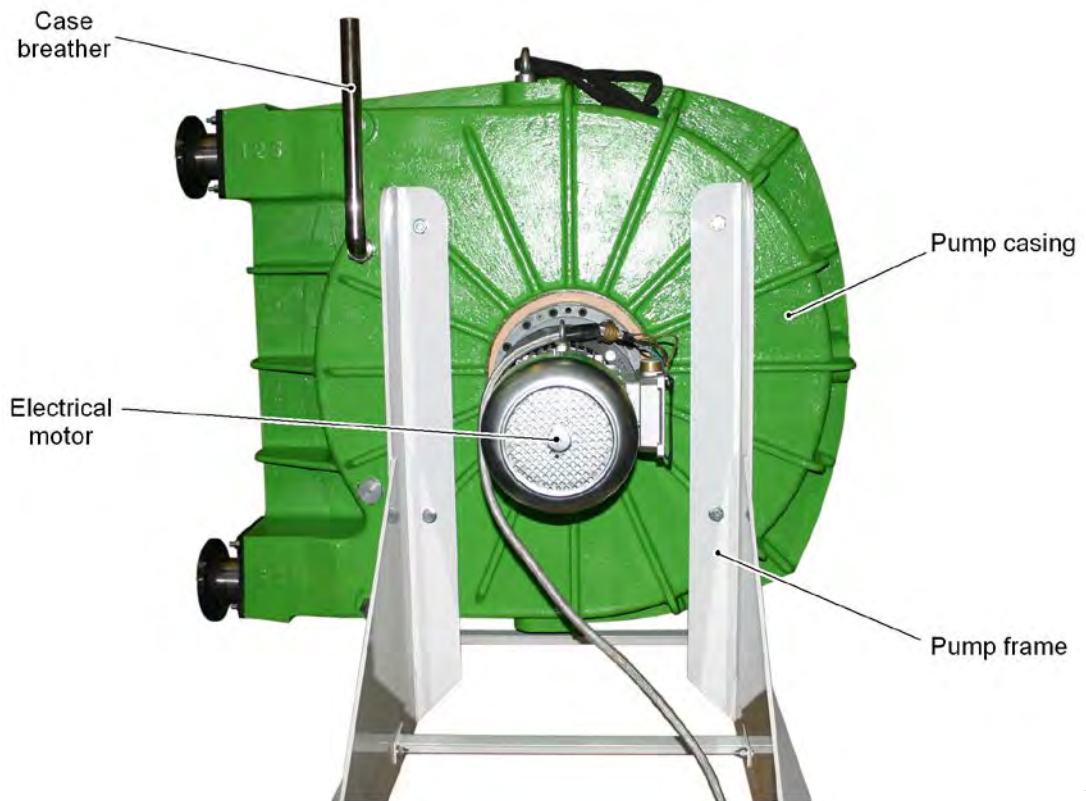

VER/002

Fig 2 VF125 Pump unit (rear view)

Limitations of the Pump

11 Verder is strongly committed to the belief that the customer must always be given as much information as possible in order to make the best possible pump selection. For this reason the list below contains details of the few Verderflex® limitations:

11.1 Hoses are available in Natural Rubber, Nitrile Buna rubber (NBR), Ethylene Propylene Diene Monomer (EPDM) rubber and Chlorosulphonated monomer (CSM/Hypalon). This selection is suitable for the majority of applications, but there remain some products which are not compatible with the hose material.

11.2 Hose pumps often appear bulky and large in size when compared to other positive displacement pumps with moderate flow rates.

11.3 When compressing the hose, the overall volume of the sliding shoe causes the volume of the suction line to be transferred to the discharge line, temporarily stopping the flow in both the suction and discharge lines.

12 Pulsation dampeners are needed occasionally as an accessory if:

12.1 The lines are hammering.

12.2 Lines are smaller than the size of the pump.

12.3 The process is hammering and/or lines are long.

12.4 Severe pulsation is noticed (product that has a high specific gravity).

12.5 The capacity of the pump may drop below expected, due to high impulse losses on the suction or discharge side or low suction side inlet pressure.

12.6 The maximum impulse loss possible on the suction side is 20-40 kPa (3 to 6 PSI) depending on hose material.

12.7 The maximum impulse loss possible on the discharge side is 750-1200 kPa (105-170 PSI), dependent on the pump type.

12.8 Max suction side inlet pressure is 2 bar / 30 PSI minimum value is 20 kPa abs/3 PSI abs.

Pump Selection

13 The pump's speed and consequent output achieved will depend on many factors:

13.1 Is the medium being pumped aggressive, abrasive, and viscous or shear sensitive?

13.2 What type of use is required for the pump, all day every day or short, periodic use?

13.3 Is the system a high or low-pressure system?

13.4 Is the medium being pumped at a high or low temperature?

13.5 What is the solid content - percentage of solids, shape and size of particles?

14 All these factors should be taken into consideration when selecting the pump size and speed of operation. If you have any reservations, do not hesitate to contact your local Verder distributor, who will be more than pleased to offer professional, expert advice and recommendations to ensure you get the optimum pump for your application.

Drive Selection

15 Your Verder distributor will be pleased to select a suitable drive to best fulfil the needs of the duty you require. You should ensure that the drive selected is sufficiently powerful to overcome the starting torque requirements of the pump at the pressure at which it is shimmed to operate - refer to the starting torque settings in the table below:

TABLE 2 – DRIVE SELECTION TORQUE RANGE

Starting Torque (1)	VF100 Range (Nm) (2)	VF125 Range (Nm) (3)
0 bar 5 bar 7.5 bar 10 bar 15 bar	5600 (4100 lb/ft) To 12300 (9070 lb/ft)	11000 (8110 lb/ft) To 27500 (20280 lb/ft)

Accessories and Options

16 There are a number of accessories available to complement the Verder hose pumps, all of which are available through your local Verder distributor:

Pulsation Dampener

17 A pulsing delivery is often common with hose pumps, which can lead to increased pipe losses or heavy pulsation in the pipeline; pulsation may be equally undesirable for the successful execution of the process.

18 In many cases, a flexible bellow is installed and impinged on one side by compressed air or gas. Should pulsation occur, the bellows increase their capacity compressing the air or gas. Hence the peak pressure is not diverted into the pipeline or system, but is absorbed by the dampener. There are three different types of dampener available:

18.1 Manual adjustment dampener.

18.2 Automatically adjusted dampener.

18.3 Preset dampener (mostly used for high pressures where a normal air network would fail to deliver sufficient pressure).

18.4 We do not recommend the use of “bladdered” dampers with high solid content slurries due to the high incidence of bladder tearing. In such cases, a suitably designed air dome is preferred where a simple air volume is used to provide a damping counter pressure.

19 Your Verder distributor will be able to advise you further by referring to the separate sales literature available. It should be noted that whilst pulsation dampers will reduce the size of the pulse (typically by approx. 90%), they will not totally eliminate pulsation.

Hose Failure Detection

20 One of the Verder's many advantages is the exceptional lifetime of the hoses. Normal wear does take its toll on the hose and in time it will need to be exchanged for a new one. Throughout the hose's lifetime, it is essential that any possible failure is noticed in sufficient time to prevent leakage into and possible damage to the pump housing and unit.

21 To prevent this, Verder has developed a sensor to be screwed into the fill pipe. If a hose does rupture, the liquid leaking into the housing will cause the fluid level to rise. Where the level in the filler tube reaches the height of the sensor, an alarm sounds and either the motor shuts down or the valves close automatically.

VFOCS Hose Burst Switch

22 The VFOCS hose burst pressure switch can be used on applications of 2 bar and over and is mounted direct to the back of the casing.

RPM sensor

Is installed through the inspection window and triggered by a target on the rotor.

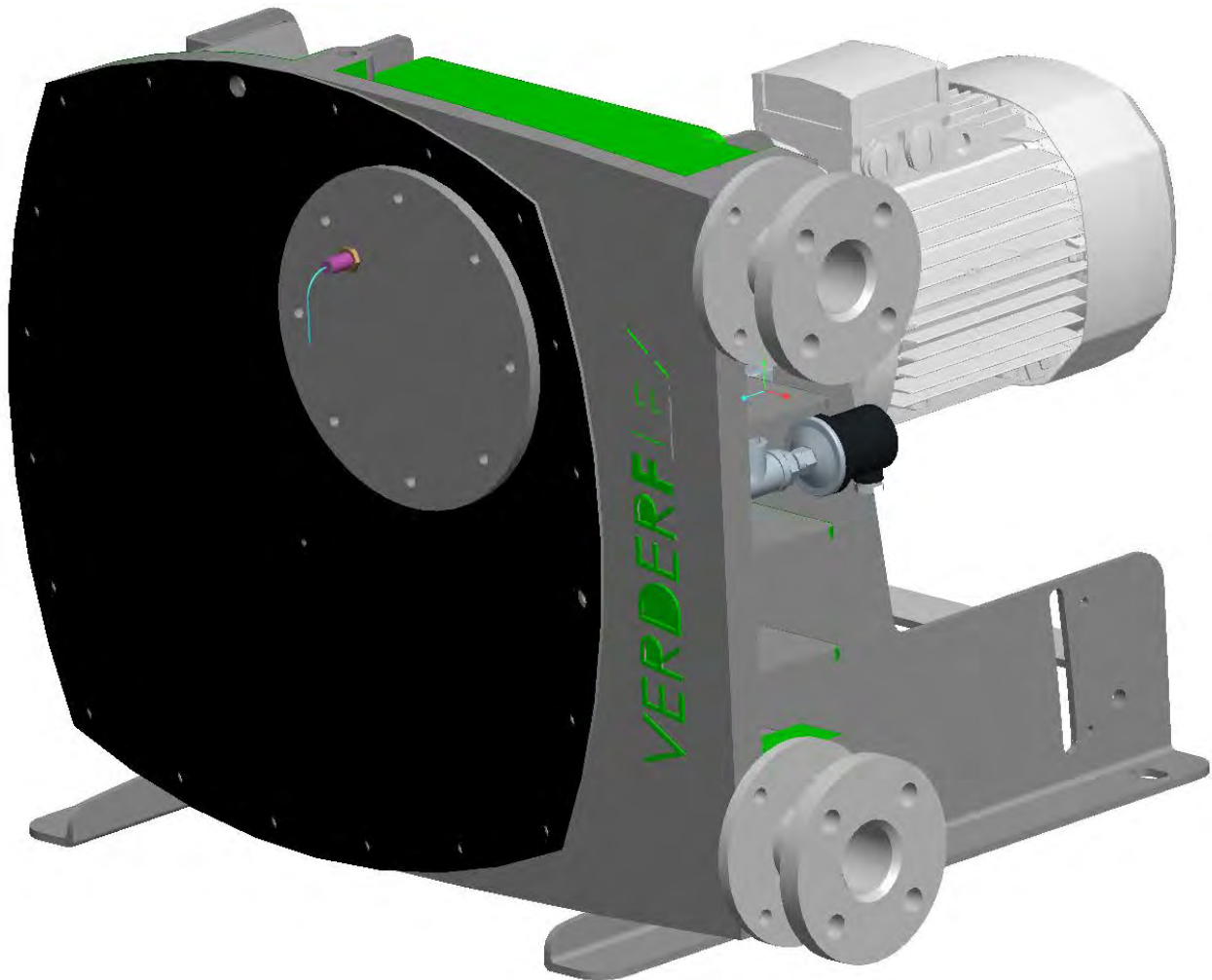

VER/065

Fig 3 RPM Sensor Installation

TABLE 3 PCD RECOMMENDED OFFSETS

Ser	Pump Model	Recommended PCD	Offsets
(1)	(2)	(3)	(4)
1	VF100	Ø 1000 Rear casing	91mm
2	VF125	Ø 1230 Rear casing	114mm

Piping Guidelines

25 Verder recommends the following regarding the setup of piping:

25.1 Pipework should be as short and direct as possible.

25.2 Sharp and multiple bends should be avoided.
Bends should be gentle & have large radius, ideally 10 x the hose ID.

25.3 Use Y junctions and avoid T joints.

25.4 Suction side pipe work should never be under-sized (the minimum bore should be equal to the hose's internal diameter).

Ideally it should be at least 150% of the pump size e.g. for a VF50 which uses a 50 mm or 2" ID hose the suction line ID should be at least 75mm (practically DN80) or 3". Larger ID's may be required as the product specific gravity (SG) , viscosity or line length increase. Please consult your Verderflex distributor in such cases.

25.5 Pulsation dampers or air dome accumulators should be mounted as close as possible to the pump's suction or discharge port. Mounting these away from the port reduces the effect of the damper by 10% for every 1m or 3' distance from the port.

25.6 Include a short, removable section next to the pump for easy access (hose changes etc). Preferably this should be a flexible hose.

25.7 Lines should include isolation valves for product drain down.

25.8 A hose pump is a positive displacement pump and it is good engineering practice to include a discharge line pressure relief device (closed valve or "dead head" protection).

25.9 Mount non-integrating flowmeters remote from the pump's discharge port as pulsation may distort readings.

25.10 Fit expansion joints to Pipework to mitigate effects of pulsating flow on Pipework.

25.11 Whenever flexible hose connections are used ensure that the hose is made from a suitably elastomer & is adequately rated for the system's maximum suction or discharge pressure.

25.12 In cases where the pumped fluid contains particles that are liable to settle using the upper port flange as the inlet flange is advised.

Verderflex VF100



VERDERFLEX®

Standard Materials of Construction

Description	Material	Weight (kg)	Paint Detail
Pump Housing	Cast Iron (GG25)	900	RAL 6018 (Green)
Front Cover	Mild Steel (BS EN10.025:1993/5275)	114	RAL 7021 (Black)
Rotor	Cast Iron (GG25)	260	
Rotor Shoes	Aluminium (6082T6)	50	
Flanges	Mild Steel (BS EN.10.025 FE430A)	13 each	
Inserts	Stainless Steel (316L) Polypropylene P.V.D.F	4	
Base Frame	Carbon Steel	190	RAL 7035 (Grey)
Lubricant	Verderlube - Glycerine based compound Verdersil - Silicone oil	60 litres	
Hose	NR, NBR, NBR Food Grade, CSM and EPDM	35	
Close coupled pump unit		2346	

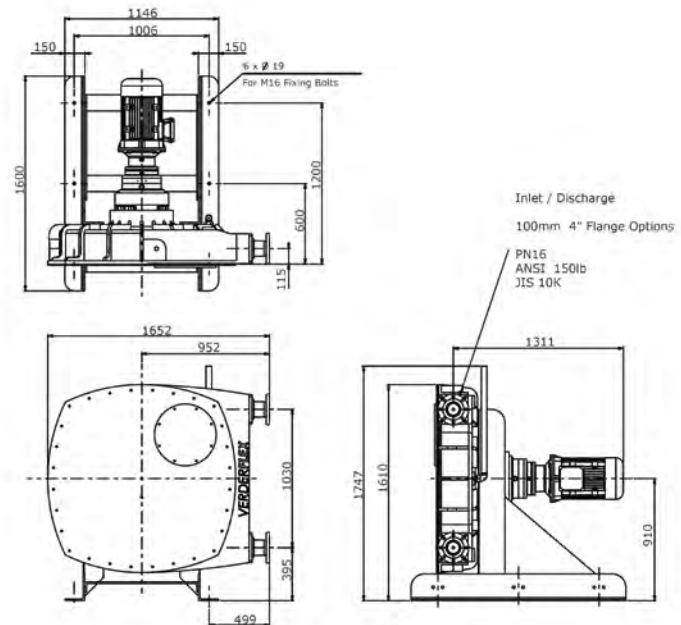

All dimensions are in mm.

All dimensions and weights are for guidance only.

Verderflex VF100

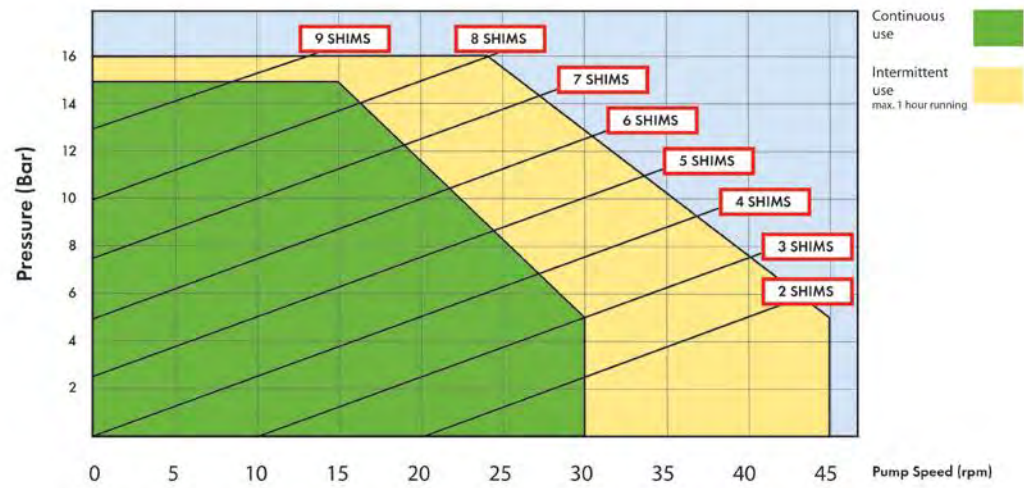
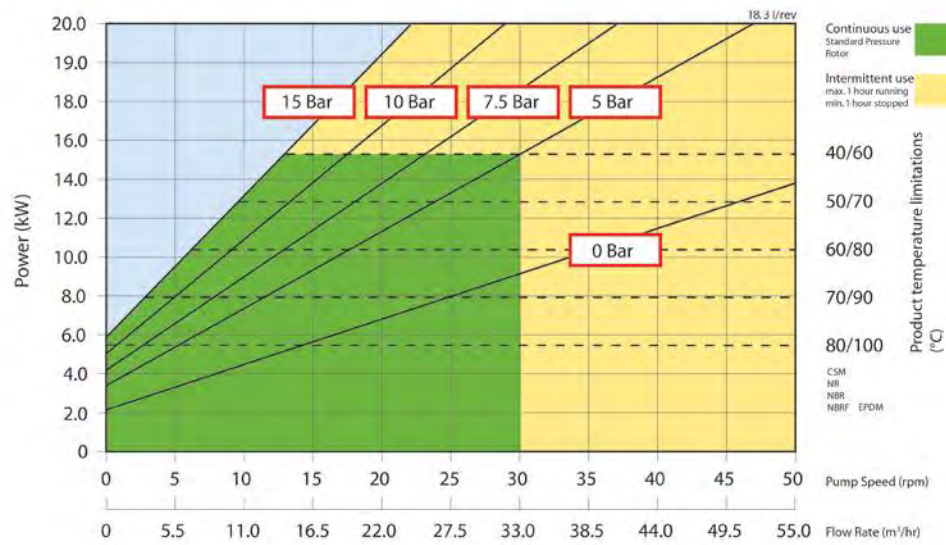

Verderflex VF125



VERDERFLEX®

Standard Materials of Construction

Description	Material	Weight (kg)	Paint Detail
Pump Housing	Cast Iron (GG25)	1355	RAL 6018 (Green)
Front Cover	Mild Steel (BS EN10.025:1993/5275)	140	RAL 7021 (Black)
Rotor	Cast Iron (GG25)	295	
Rotor Shoes	Aluminium (6082T6)	80	
Flanges	Mild Steel (BS EN.10.025 FE430A)	15 each	
Inserts	Stainless Steel (316L) Polypropylene P.V.D.F	8	
Base Frame	Powder Coated Carbon Steel	210	RAL 7035 (Grey)
Lubricant	Verderlube - Glycerine based compound Verdersil - Silicone oil	80 litres	
Hose	NR, NBR, NBR Food Grade, CSM and EPDM	43	
Close coupled pump unit		3146	

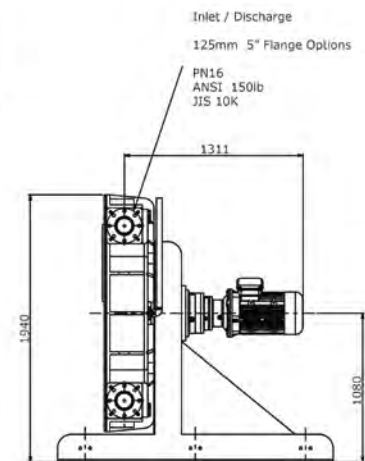
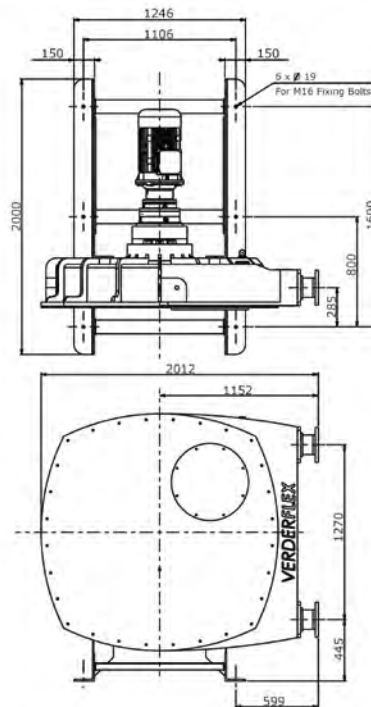

All dimensions are in mm.

All dimensions and weights are for guidance only

Verderflex VF125

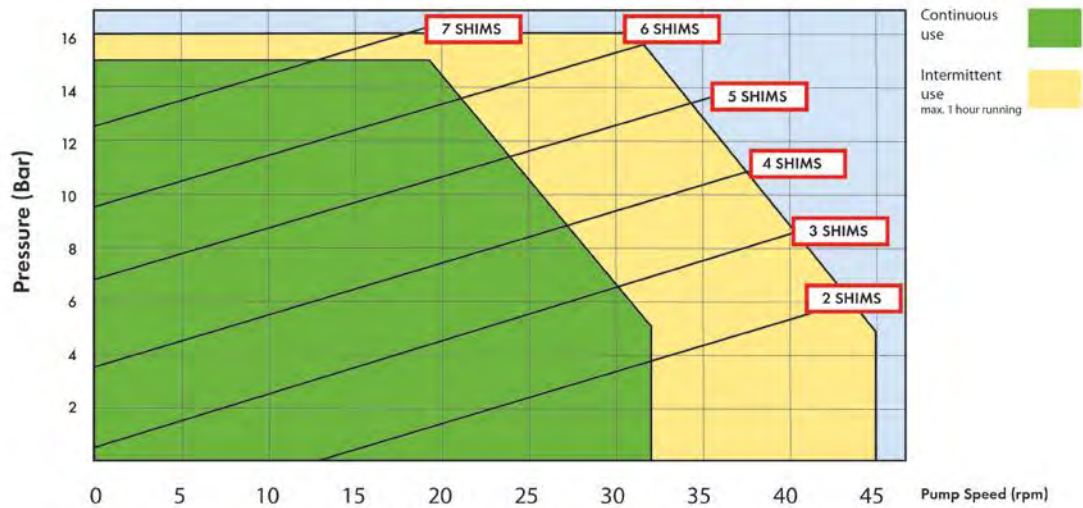
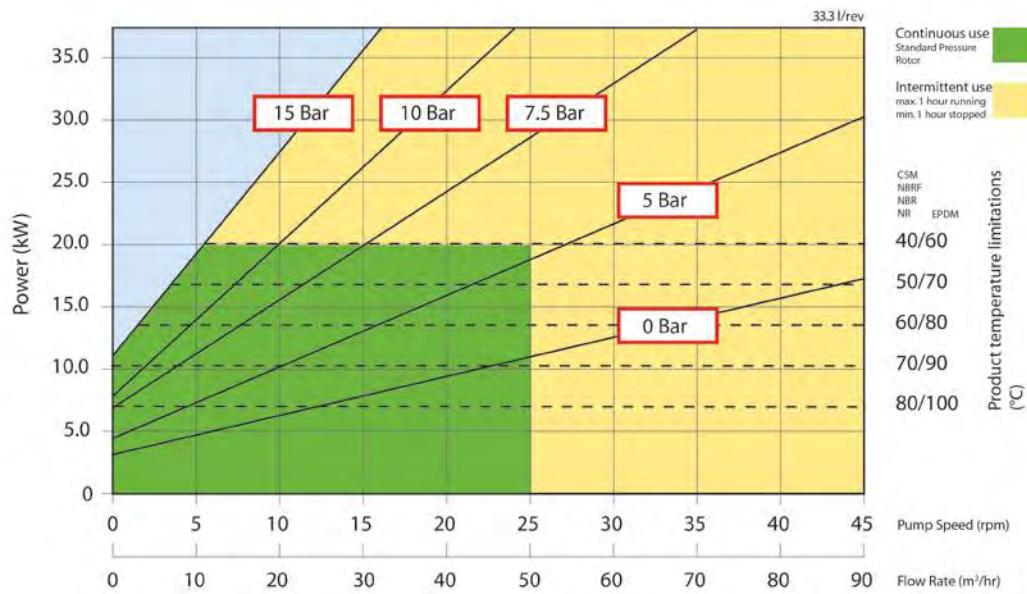

CHAPTER 4

INSTALLATION & FAULT FINDING

CONTENTS

Task	Page
Maintenance Safety (WARNINGS)	4.0
1 Frame assembly build	4.2
2 Pump case installation	4.3
3 Drain & blanking plug installation	4.4
4 Breather installation	4.5
5 Electrical motor and gearbox installation	4.6
6 Rotor build and installation	4.8
7 Front cover installation	4.13
8 Electrical power installation	4.14
9 Port flange build	4.15
10 Hose installation	4.17
11 Pump casing lubricant	4.21
12 Inspection cover installation	4.21
Table	
1 Pump fastener torque figures	4.22
2 Fault Finding	4.22

MAINTENANCE SAFETY

WARNINGS



LETHAL VOLTAGES. Dangerous voltages exist within this equipment. Only a fully qualified electrician should work on electrical components. Always isolate the power supply before working on the pump.



SAFETY HAZARD. Do not stand near the pump while the hose is being removed – if the hose is expelled too quickly, it could cause serious injury.



SAFETY HAZARD. Never try to install a hose without the front cover in place, it could cause serious injury.



SAFETY HAZARD. Never remove the front cover when the hose is still in position, it could cause serious injury.



HEAVY WEIGHT. When moving heavy weights, lifting equipment should be used to support the weight.



HEAVY WEIGHT. Always use lifting equipment safely in accordance with the manufacturer's recommendations.



HEAVY WEIGHT. The pump is provided with a lifting eye, which can be fitted into the threaded hole of the front cover, (located by removing the top left of centre front cover fastening bolt) to assist with lifting.



HEAVY WEIGHT. Take care not to drop the front cover as this is likely to cause serious injury.



SAFETY HAZARD. Do not stand in the immediate vicinity of the pump when operating with the inspection cover removed; follow safety procedures for operation of pump with inspection cover off.



HEAVY WEIGHT. Care should be taken to support the weight of the rotor shoe whilst the bolt is being removed – similarly care should be taken not to drop the shoe after removal from the pump rotor.



SAFETY HAZARD. Extreme care must be taken when removing the rotor. When the rotor comes away from the pump shaft, it will tend to swing out on the lifting equipment, potentially causing serious injury - stand well clear.



EQUIPMENT DAMAGE. Before test running the pump, check that all tools are removed, particularly from pump casing.



EQUIPMENT DAMAGE. Correct torque figures must be applied when using Torque wrench adaptors. Pump casing and electrical motor mounting bolts require the use of these adaptors.

1 FRAME ASSEMBLY BUILD



Assembly of the VF100 and VF125 pumps are similar; the build of a VF125 is used in this document.

Using suitable lifting equipment prepare the frame for assembly in an area large enough to accommodate the pump. We recommend the pump is assembled onto a pallet or wheeled bogie to facilitate movement.

VER005

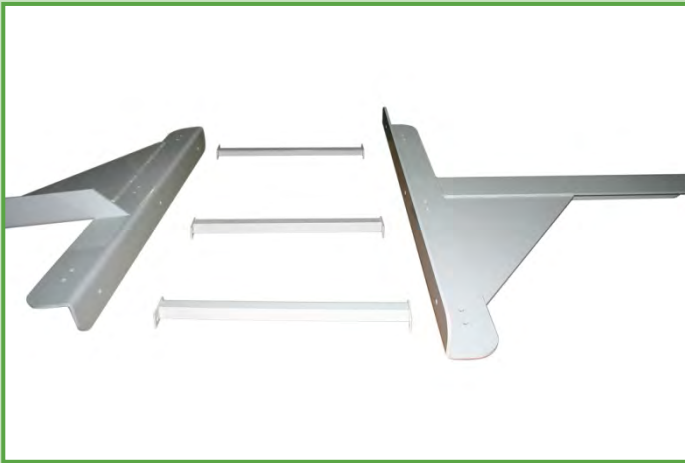

Frame sizes and weights differ slightly across the range.

Raise one frame side and loosely fit the frame cross members to one side of the frame using the frame fixing kit.

(Refer to Chap 6)

VER006



Raise the second side and loosely fit to the cross members using the appropriate fixing kit.

VER007



2 PUMP CASE INSTALLATION



With suitable lifting equipment manoeuvre the pump casing to the frame.



Align the pump casing mounting holes to the pump frame mounting holes.

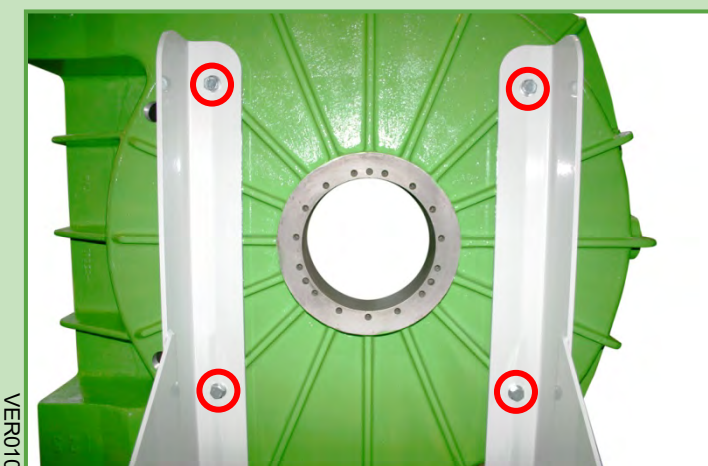

Secure the pump casing to the frame using the appropriate fixing kit.

(Refer to chap 6)

VER014



Torque-tighten the four mounting bolts.
(Refer to Table 1 for torque figures)

VER015



Torque-tighten the loosely fitted cross
member fasteners.
(Refer to Table 1 for torque figures)

3 DRAIN & BLANKING PLUG INSTALLATION

VER016

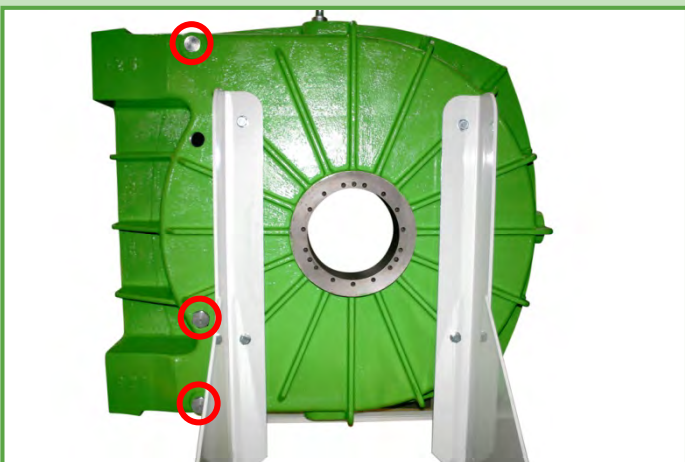

Install the top and bottom
drain/blanking plugs complete with
Dowty sealing washers.



Torque-tighten the plugs.

(It is recommended to use PTFE tape or liquid PTFE on the threads to help prevent any leakage).

(Refer to Table 1 for torque figures)

VER011

4 BREATHER INSTALLATION



Install the pump casing breather tube to the pump casing.

VER012

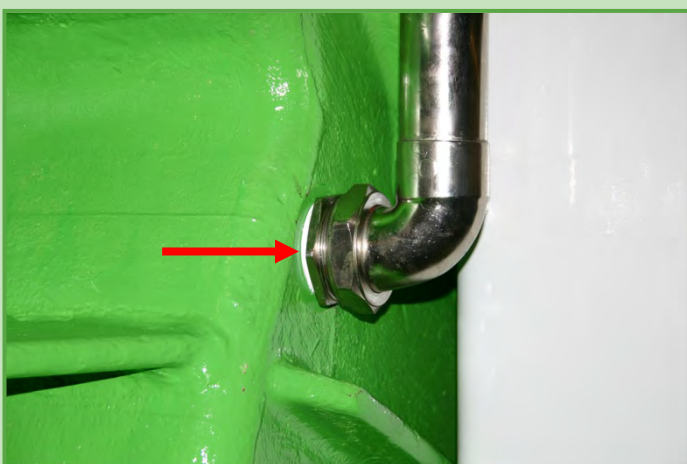

Use PTFE tape or liquid PTFE on the threads to prevent any leakage.

VER013

5 ELECTRICAL MOTOR AND GEARBOX INSTALLATION



Brush a small amount of general purpose grease around the gearbox/motor flange on the pump casing.



Align the gasket over the holes on the flange (the grease will hold the gasket in place).

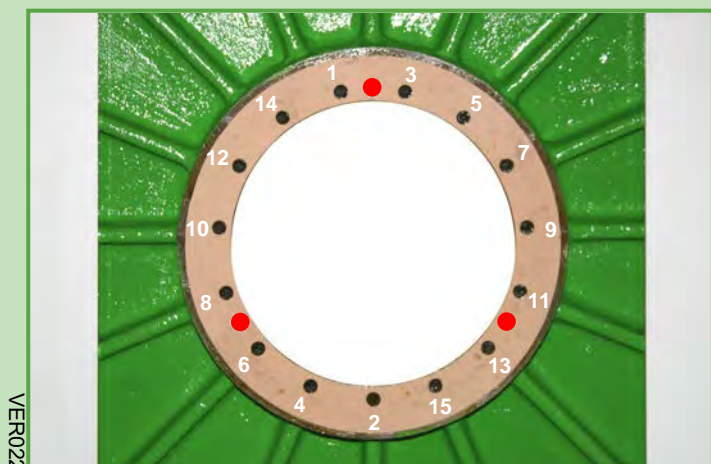

Dowel pin locators and torque-tightening sequence.

Fit the dowel pins into the pump casing.

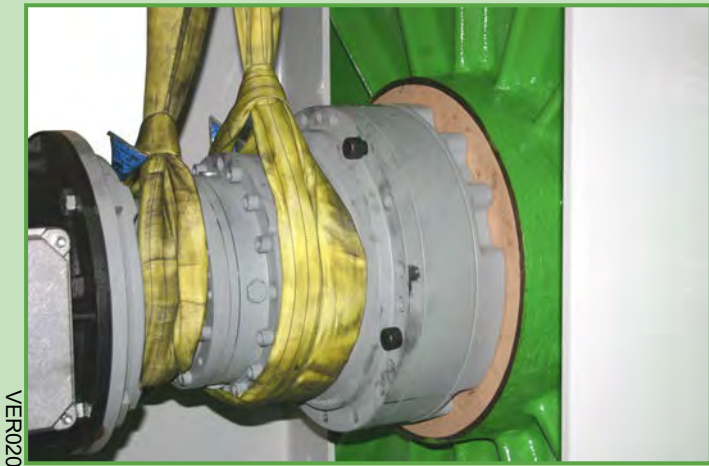

Locate the three dowel pins on the motor/gearbox, with the three holes in the pump casing flange. Use one or two cap head screws to hold the motor/gearbox in place.

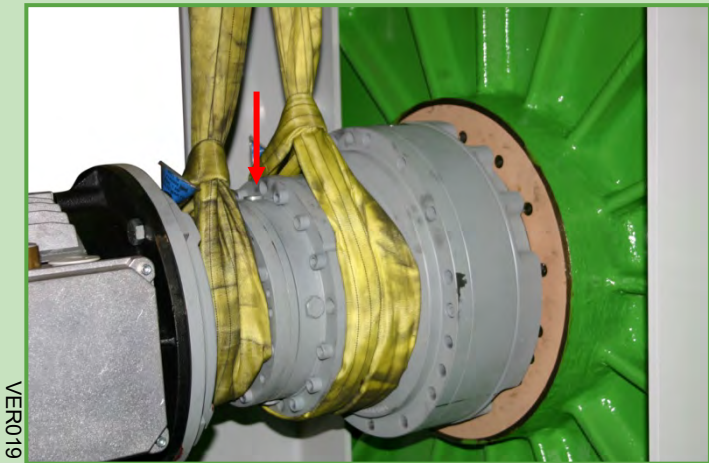

Using suitable lifting equipment; offer the motor/gearbox up to the pump case flange. The gearbox filler plug should be positioned uppermost (arrowed).

Use the dowel pins to align the gearbox to the pump.

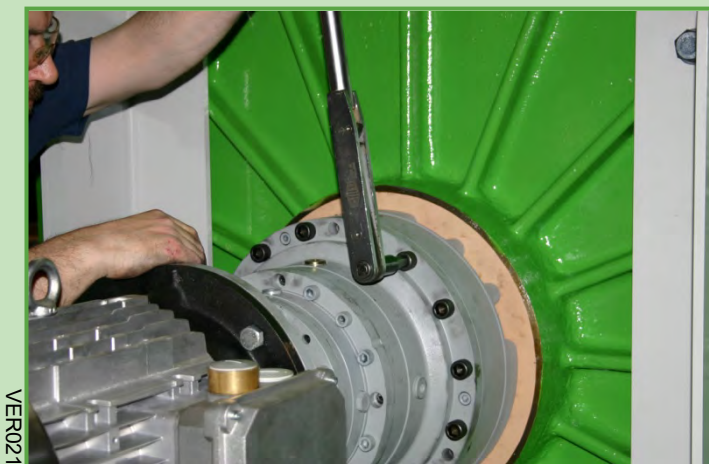

Fit the rest of the cap head screws then torque-tighten each cap head screw.

(Refer to Table 1 for torque figures)

6 ROTOR BUILD AND INSTALLATION

VER023



Using suitable lifting equipment; place the rotor wheel on a work bench to facilitate the fitting of the rotor shoes.

VER024



Loosely fit the two rotor shoes to the rotor with appropriate fasteners.

VER025



Insert the required shim(s) between the rotor shoes and the rotor.



VER026

Torque-tighten fasteners on each shoe.
(Refer to Table 1 for torque figures)



VER027

Fit the taperlock bush to the rotor.



VER028

Loosely fit the set screws to the taperlock bush.

VER029



Before fitting the rotor wheel to the gearbox shaft; fit the front cover 'O' ring (use some grease to hold it in) and fit four M10 studs to the pump case (indicated).

VER030



Using suitable lifting equipment align the centre of the rotor to the gearbox shaft.

VER031



Remove the fan cover from the electric motor and turn the fan to rotate the gearbox shaft.



Rotate the fan until the gearbox shaft keyway is aligned with the cut away in the taperlock bush.

VER032



Use a piece of wood as a drift to drive the rotor onto the gearbox shaft.

VER033



Drive the rotor onto the gearbox shaft until the shaft protrudes through the taperlock bush.

Do not strike the rotor.

VER034

VER035



To ensure that the rotor shoes are centred on the hose when running; it is critical that the rotor wheel is positioned on the shaft. Place a straight edge against the machined edge of the pump casing and outer edge of the rotor (not the shoe). A measurement of 27.5 mm (VF100) and 30mm (VF125) should be recorded (the distance between the front cover and rotor). Drive the rotor onto the shaft until this measurement is achieved.

VER036

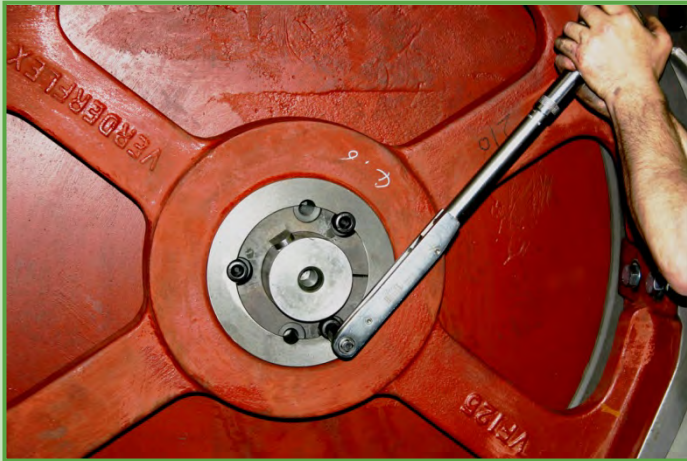

Torque-tighten the cap head screws; re-check the measurement to allow for any movement, and adjust as necessary. The electrical motor cover can now be refitted.

(Refer to Table 1 for torque figures)

VER037



Tip

Use pieces of wood as chocks to prevent the rotor from rotating when tightening the cap head screws.

7 FRONT COVER INSTALLATION

VER038



Fit the front cover lifting bracket to the cover using two fasteners from the front cover fastening kit; torque-tighten.

(Refer to Table 1 for torque figures)

VER039



Using suitable lifting equipment mount the cover to the pump case.

VER040



Secure the cover to the four mounting studs using four nuts and four washers.

VER041



Remove the lifting bracket and fit the twenty four bolts and washers to the cover; torque-tighten all the fasteners.

(Refer to Table 1 for torque figures)

VER042

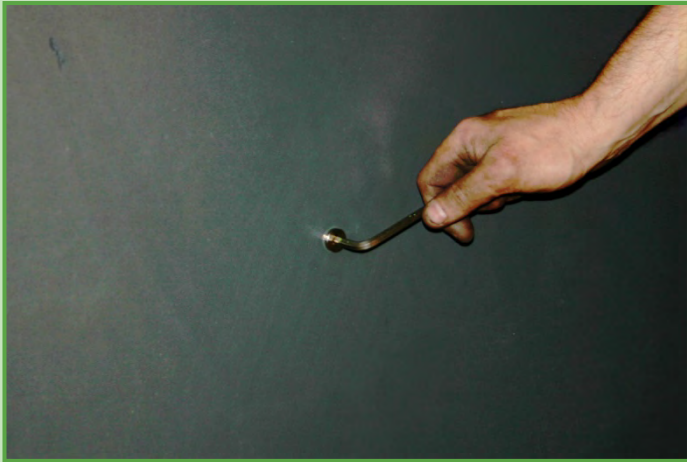

Fit the lube level plug to the front cover.

8 ELECTRICAL POWER INSTALLATION

VER043

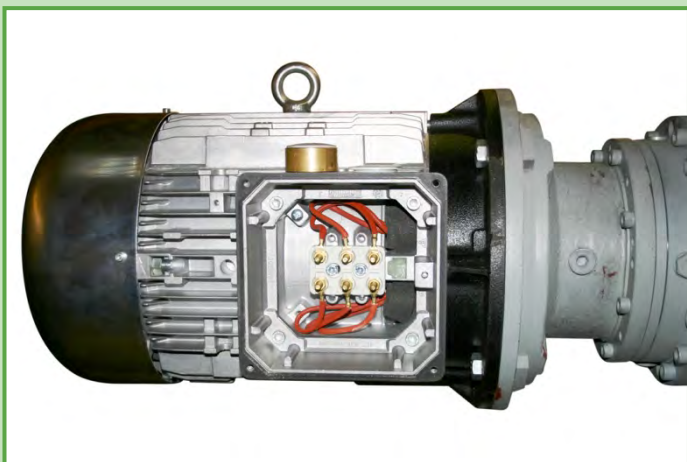

Electrical connections can only be made by suitably qualified personnel who are fully certified to, and conversant with prevailing local and national electrical regulations.

Remove the side cover from the electrical motor to expose the electrical connectors.

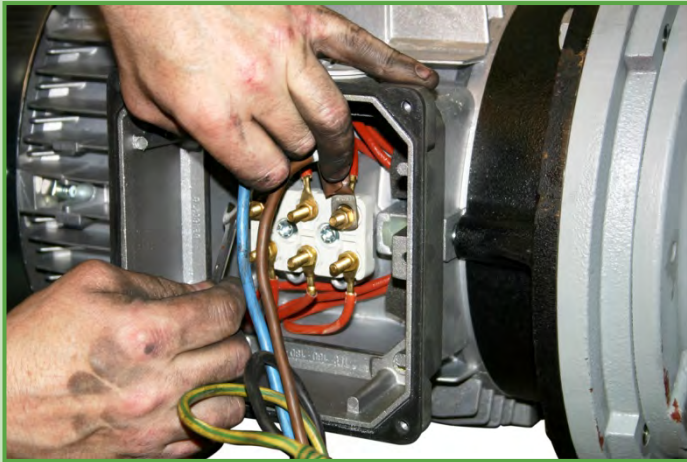

Install the power supply and re-fit the electrical motor cover.

VER044

9 PORT FLANGE BUILD



To build the two port flange assemblies fit the outer 'O' ring to each of the port flange outer halves.

VER045



Fit the insert gaskets to the port flange insert halves (threaded end uppermost).

Note: Plastic inserts use nuts and bolts.

VER046

VER047



Fit the square port outer flange over the insert.

VER048

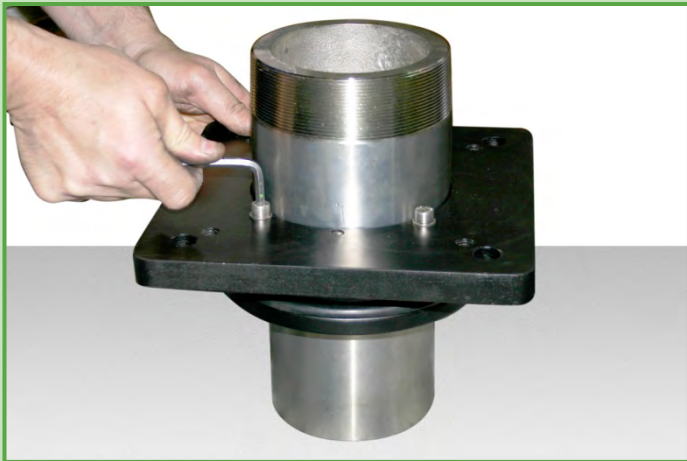

Secure together with four cap head screws and four washers.

Note: Plastic inserts use nuts and bolts.

VER049



Insert two dowel pins either side of the port flange assemblies.

10 HOSE INSTALLATION



Insert the hose into the suction casing port then push the hose into the port until it abuts against one of the rotor shoes.

Tip

Apply Verderlube onto the hose to aid installation.



Using electrical power operate the electrical motor; and slowly rotate the pump rotor wheel until it grabs the hose and moves it around the casing until it protrudes through the top casing port.



Reverse the motor if the hose protrudes out too much.

VER053

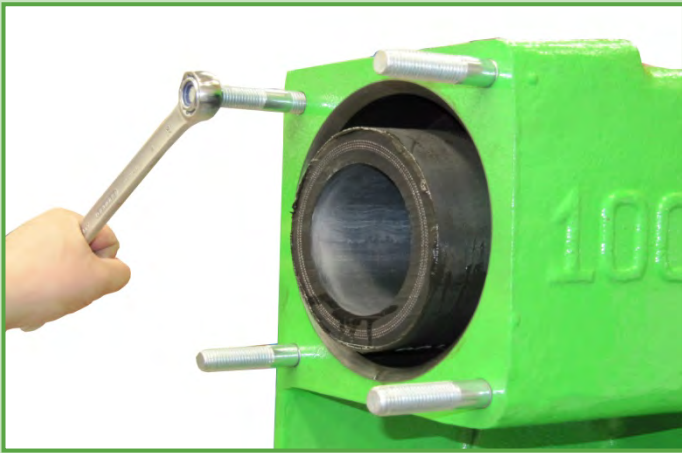

Install four studs to the upper port flange.

VER054



Fit the sealing ring over the hose and allow for a 1-2mm protrusion of the hose through the sealing ring.

VER055



Fit the port flange assembly and secure with four nuts and four washers; torque-tighten.

(Refer to Table 1 for torque figures)



Operate the pump so that the hose oscillates out of the bottom port and centralizes itself underneath the rotor shoes.



Remove the excess hose protruding out of the discharge port with a hacksaw.



Fit the sealing ring to the bottom part of the hose.

VER059

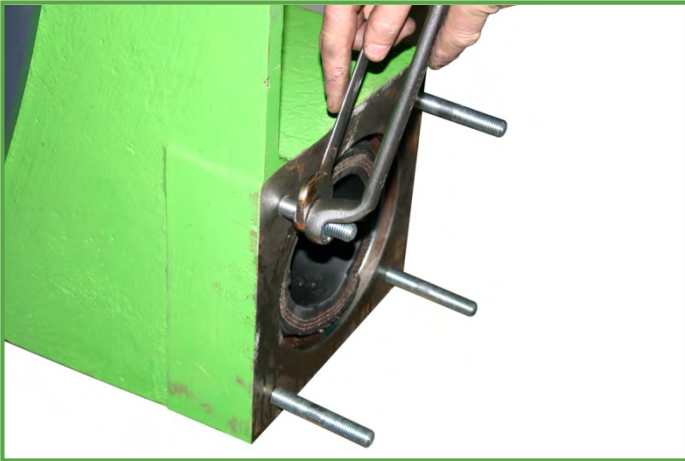

Fit four studs to the lower port.

VER060



Fit the port flange and secure with four nuts and four washers; torque-tighten.

(Refer to Table 1 for torque figures)

VER061



Fit the top and bottom screw-on flanges.

11 PUMP CASING LUBRICANT

VER062



Fill the pump casing with the correct amount of lubricant.

(Refer to chap 2)

12 INSPECTION COVER INSTALLATION

VER063

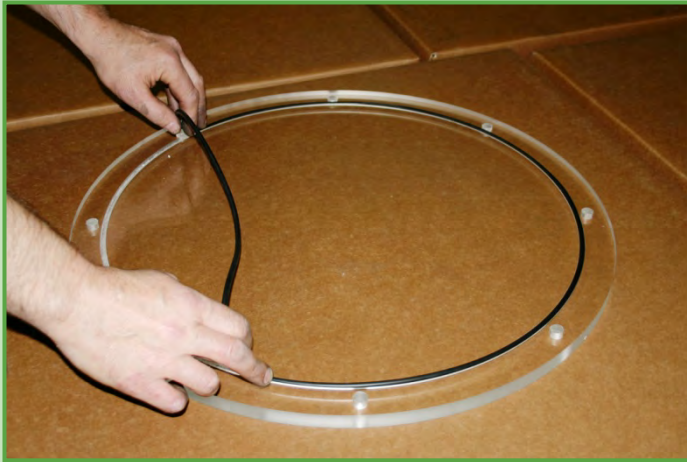

Fit the inspection cover 'O' ring to the inspection window

VER064

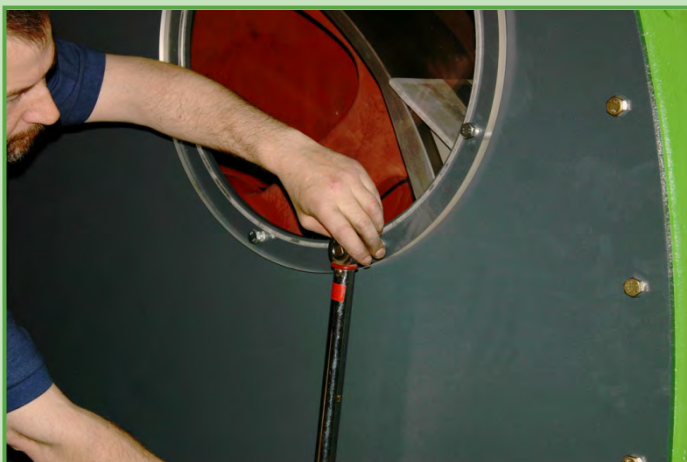

Secure the inspection window to the pump case with eight bolts, eight nylon washers; and eight dowty washers. Torque-tighten (taking care not to over tighten as the window edges may crack).

(Refer to Table 1 for torque figures)

The pump is now ready to be commissioned (Refer to chap 2).

TABLE 1 PUMP FASTENER TORQUE FIGURES

Table 1 is to be used as a guide to torque-tightening of pump fasteners:

Ser (1)	Position (2)	Torque Nm (3)	
		VF100	VF125
1	Mounting Frame	55	55
2	Cross member	55	55
3	Rotor shoe	115	115
4	Front cover	55	55
5	Inspection window	6.5	6.5
6	Port flange	55	55
7	Gearbox	55	55
8	Taper lock bush	270	270

TABLE 2 FAULT FINDING

Table 2 is to be used as an aide to fault finding.

Serial (1)	Fault (2)	Probable Cause (3)	Corrective Action (4)
1	Abnormally high pump temperature	Non-standard lubricant	Consult Verder distributor to obtain correct lubricant
		Low lubricant level	Add required amount
		Product temperature too high	Consult Verder distributor regarding maximum temperature
		Internal friction on hose caused by blocked suction or bad suction characteristics	Check pipe-work/valves for blockages; check that the suction pipe-work is as short and as large in diameter as feasible; consult Verder distributor for advice
		Over shimming of the pump	Check & remove excess shims
		High pump speed	Reduce speed to a minimum; consult Verder distributor for advice on recommended pump speeds
2	Low capacity/pressure	Suction/discharge valve closed	Open suction/discharge valve
		Under shimming of the pump	Check & add shims as required
		Hose failure	Replace hose
		Blocked suction/no product	Check suction pipe-work for blockages and product; remove any product
		Poor pump selection	Consult Verder distributor to check pump selection
		Suction line too long, pump speed too high, suction line bore too small.	Consult Verder distributor for advice
		High product viscosity	Use vacuum on housing

(continued)

TABLE 2 FAULT FINDING (continued)

Serial (1)	Fault (2)	Probable Cause (3)	Corrective Action (4)
3	Pump and pipe-work vibrating	Suction/discharge lines not secured properly	Check and secure suction/discharge lines
		High pump speed, long suction/discharge lines, high product specific gravity, or a combination of them all	Reduce pump speed, shorten suction/discharge line wherever possible; consult Verder distributor
		Under-sized suction /discharge diameter	Increase suction/discharge pipe-work diameter
4	Hose pulled in to pump housing	Insufficient lubricant in the casing	Check lubrication chart and add the required amount of lubrication
		Inlet pressure too high	Reduce the inlet pressure
		Blocked hose	Check the hose and remove any blockages
		Large particles in the product	Mount sieve/filter in suction line to avoid particles entering the hose

CHAPTER 5

MAINTENANCE AND SERVICING

CONTENTS

Para		Page
	Maintenance Safety (WARNINGS).....	5.0
	Pump & Hose Storage.....	5.1
1	Introduction.....	5.1
2	Hose Pre-Storage Actions.....	5.1
3	Pump Pre-Storage Actions.....	5.1
4	Hose storage and shelf life.....	5.1
6	Lubrication (CAUTIONS).....	5.2
9	External checks.....	5.3
Table		
1	Service/Replacement Components.....	5.2
2	Pump Lubricants.....	5.3
3	External Checks.....	5.3

Maintenance Safety

WARNINGS



LETHAL VOLTAGES. Dangerous voltages exist in this equipment. Always isolate the power supply before working on the pump.



SAFETY HAZARD. Always follow the safety procedures for handling the product being pumped.



SAFETY HAZARD. If the hose has ruptured, the lubricant may be contaminated with product and the pump casing may be pressurized – care must be taken to handle the mixture appropriately and appropriate measures taken to relieve any pressure build up.



SAFETY HAZARD. Do not stand near the pump while the hose is being removed – if the hose is expelled too quickly, it could cause serious injury.



Always use lifting equipment safely in accordance with the manufacturer's recommendations. The pump is provided with a lifting eye, which can be fitted into the threaded hole of the front cover, (located by removing the top left of centre front cover fastening bolt) to assist with lifting.



HEAVY WEIGHT. Take care not to drop the front cover as this is likely to cause serious injury.



SAFETY HAZARD. Do not stand in the immediate vicinity of the pump when operating with the inspection cover removed; follow safety procedures for operation of pump with inspection cover off.

PUMP & HOSE STORAGE

Introduction

1 Verderflex® pumps are designed for continuous use; however, there may be instances when pumps are withdrawn from use and stored for periods of more than 2 weeks. We recommend certain pre-storage actions and precautions be taken whilst pumps and their components are not in use. Similarly, hoses and lubricants may be held as stock to service working pumps and their recommended storage conditions are advised.

Hose Pre-Storage Actions

- 2 The hose should be removed from the pump and the lubricant drained out of the pump casing.
 - 2.1 The pump casing should be washed out and allowed to dry and any build up of product removed.
 - 2.3 The gearbox should be drained and re-filled with oil in accordance with the manufacturer's recommendations.

Pump Pre-Storage Actions

3 Pumps should be stored in a dry environment. Depending on these conditions, it may be advisable to place a moisture-absorbing product, such as Silica gel, inside the pump's casing or to coat the pump's inner surfaces with moisture-repelling oil, whilst the pump is stored.

- 3.1 Gearboxes may require intermittent attention (such as periodic rotation) as indicated by the gearbox manufacturer's recommendations.
- 3.2 Hoses should be stored as supplied in their wrapper and should be stored away from direct sunlight and other sources of ultra violet light and at room temperature of between 10 to 20 °C.
- 3.3 Lubricants should be stored under normal warehouse conditions with their caps securely fastened.
- 3.4 It is recommended that lubricant containers be inverted every month and shaken before being used in the pump.

Hose storage and shelf life

4 Shelf life for hoses is approximately two years for NR and NBR hoses, and approximately four years for EPDM hoses. The hoses should be stored flat in a cool, dark location and should not come in contact with any ultra-violet lighting; otherwise the product will be aged artificially.

TABLE 1 SERVICE/REPLACEMENT COMPONENTS

5 Table 1 lists the sub components that may require replacement and recommended change times after maintenance.

Serial (1)	Item (2)	Related Sub Components (3)	Recommended Change (4)
1	Port Flanges	Sealing Rings (Flange sealing kit) Inner Port Flange 'O' rings Outer Port Flange 'O' rings Inner Gasket	Every 2 nd hose change Every hose change Every hose change Every insert change
2	Front Cover	Front cover 'O' ring Inspection window 'O' ring	Every removal Every 12 months
3	Gearbox	Top up/replenish with recommended OEP gear oil.	Check Every Hose Change & Replace every 12 months
		Drive Gasket	Every gearbox removal
4	Lubricant	Flush out casing and refill	Every 6 months or hose change (whichever soonest)
5	Gearbox & Bearing Housing	Front shaft seal	Replace if pump has overrun after hose burst and not protected by a pressure switch or seal face shows signs or has been exposed to chemical attack, otherwise replace every 12 months

Lubrication

CAUTIONS



EQUIPMENT DAMAGE. At all times the pump housing needs to be at least one third full with Verderlube lubricant (future front covers will incorporate a level plug which can be used to check/maintain lubricant level).



EQUIPMENT DAMAGE. Check compatibility of the lubricant with the product being pumped; Verderlube is a specially formulated food grade lubricant containing glycerine. In most cases this is a very stable compound, but can react when mixed with certain types of substance.



EQUIPMENT DAMAGE. Do not use Verderlube with nitrogenous compounds, concentrated acids or strong oxidizing agents. If you are unsure of the chemical compatibility of your product with Verderlube, your Verder distributor will offer advice and if necessary, supply an alternative lubricant such as Verdersil.

6 The standard lubricant is Verderlube; a specially formulated food grade lubricant, which is designed to reduce the friction between hose and rotor shoe, thus reducing the wear and tear on the hose and on the shoes. The lubricant is food grade standard, blue in colour and can be used at temperatures ranging from -40°C up to 100°C (-40°F up to 210°F). Alternatively Verdersil can be used for certain chemical applications or elevated temperatures, for more information please contact your Verder distributor.

7 It is vital that lubricant levels are monitored at all times - an increase in levels of lubricant will indicate hose failure. If this occurs, the product will be contained within the pump housing, but performance will deteriorate and eventually cause product contamination. It is recommended that you fit a hose burst detection unit.

TABLE 2 PUMP LUBRICANTS

8 The pump must always be filled with the correct amount of lubricant. Table 2 shows the correct amount of lubricant to be used with VF100 and VF125 pumps in litres and US gallons.

Serial (1)	Pump size (2)	Lubricant (3)	Capacity in Litres (4)	Capacity in US Gallons (5)
1	VF100	Verderlube®/Verdersil®	60	15.8
2	VF125	Verderlube®/Verdersil®	80	21.1

External Checks

9 External checks should be carried out to help support the pumps operation and long life, and to reduce the high cost of major component failure. If there is no customer maintenance schedule then please contact your local distributor workshop for service details. Table 3 should be used as an aide memoir to facilitate external checks.

TABLE 3 EXTERNAL CHECKS

Serial (1)	Task (2)	Related Sub Components (3)	Action (4)
1	Inspect for leaks	Port Flanges ; Front Cover ; Rear drive ; Inspection Window	Repair as necessary
2	Inspect for cracks	Inspection Window	Repair as necessary
3	Inspect for security	Breather Tube ; VFOCS Hose Burst ; Level sensors & wiring	Secure as necessary
4	Check running temp	Check from below centre of front cover surface, this maybe hot, as it is dependent on pump media/discharge pressure/installation/line restrictions and ambient temperature etc.	
5	Check and tighten	Front Cover/Port Flanges/Mtg. Frame Bolts & Drain plugs. Inner Port flange ring of bolts	Tighten as necessary
6	Pressures	Check/ensure discharge pressure is maintained, if not, check for line blockage/closed valves or hose damage.	Remove blockage Open valve Repair/replace hose
7	Check pump lubricant level	Pump casing	If over-full, check hose for leakage/burst, then drain/replenish. If low check for suction line leaks & other abnormal causes of lubricant loss. If none then top up where necessary
8	Inspect Gearbox	Gearbox	Refer to Gearbox manufacturers manual.

INTENTIONALLY LEFT BLANK

CHAPTER 6

SPARE PARTS LISTS



CONTENTS

Table	Page
1 VF100 Spare Parts List	6.0
2 VF125 Spare Parts List	6.5

VF100 Spare Parts List

1 Table 1 contains a list of spares to help maintain and repair the VF100 peristaltic pump. Your Verder distributor will be able to advise you where genuine Verderflex® spares can be purchased.

TABLE 1 VF100 SPARE PARTS LIST

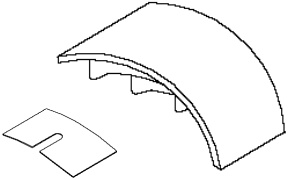
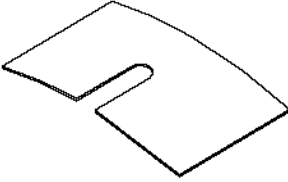
Serial (1)	Item Description (2)	Part No (3)	Qty (3)	Image (4)
1	Front Cover 'O' Ring (1260mm x 8mm)	129.1950	1	
2	Rotor	129.1964	1	
3	Rotor shoe assembly c/w shim pack	129.1362.A	1	
4	Shim pack	129.1393.M	14 Pack	







(continued)

TABLE 1 VF100 SPARE PARTS LIST (continued)

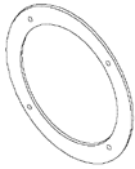
Serial (1)	Item Description (2)	Part No (3)	Qty (3)	Image (4)
5	Front cover (28 hole)	129.1927	1	
6	Hose (NR black)	129.0009	1	
7	Hose (NBR)	129.0520	1	
8	Hose (EPDM)	129.0018	1	
9	Hose CSM(black)	129.2018	1	
10	Hose NBRF (black)	129.2029	1	
11	Taper lock bush (Type 5040.110) (Type 5040.120)	129.1960 129.1963	1	No Image

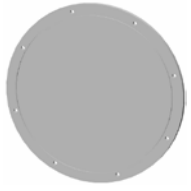
(continued)

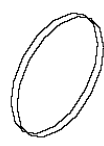
TABLE 1 VF100 SPARE PARTS LIST (continued)

Serial (1)	Item Description (2)	Part No (3)	Qty (3)	Image (4)
12	Drive Gasket	129.1937 (33 Hole) 129.2978 (18 Hole)	1	
13	Filler tube	129.1261	1	
14	Inspection cover c/w 'O' ring	129.1235	1	
15	Inspection cover 'O' ring	129.1944	1	
Flange Sealing Kits 129.1039 Comprising:-				
16	Port flange 'O' ring	129.1039	2	
17	Port flange gasket	129.1039	2	
18	Sealing ring	129.1039	2	

(continued)

TABLE 1 VF100 SPARE PARTS LIST (continued)

Serial (1)	Item Description (2)	Part No (3)	Qty (3)	Image (4)
Port flange assembly SS				
19	Port flange outer half	129.1943	2	
20	Port flange insert half	129.1976 = SS 129.1975.M = MS	2	
21	Fastener kit (Steel)	129.0908.3P	1	Image required
Port flange assembly (Plastic)				
22	Port flange outer half	129.1943	2	
23	Port flange insert half	129.1976.P = PP 129.1976.V = PVDF	2	
24	Fastener kit (Plastic)	N/A	1	Image required
25	4" Screw on flanges PN16 (BSP)	129.1952	2	Image required

(continued)

TABLE 1 VF100 SPARE PARTS LIST (continued)

Serial	Item Description	Part No	Qty	Usage
(1)	(2)	(3)	(3)	(4)
VF100 Mounting Frame assembly fastener kit (129.0908.1P)				
26	M24 washer M24X50 bolt M16X50 bolt M16 nylon insert nut M16 washer			Mounting frame to pump case Mounting frame to pump case Cross member to support frame Cross member to support frame Cross member to support frame
VF100 Rotor shoe assembly fastener kit (129.0908.2P)				
27	Split dowel pin M20 washer M20X75 bolt			Rotor shoe fastening Rotor shoe fastening Rotor shoe fastening
VF100 Port flange assembly fastener kit (129.0908.3P)				
28	M6X20 cap head screw M6 washer M6X20 cap dowel pin M16X60 bolt M16 washer			Flange to insert connection Flange to insert connection Flange to insert connection Port flange to pump case Port flange to pump case
VF100 Port flange assembly fastener kit - plastic inserts (129.9018.3P)				
29	M6 locknut M6 washer M6X35 cap head screw M16X60 bolt M16 washer			Flange to insert connection Flange to insert connection Flange to insert connection Port flange to pump case Port flange to pump case
VF100 Casing assembly fastener kit (129.0908.4P)				
30	M10X30 bolt M12 full nut M30 eyebolt			Inspection cover Front cover to pump case Front cover lifting
VF100 Optional				
31	M16X150 bolt M16 washer Ø16 Dowel pin M12X25 bolt M12 washer M12X40 stud M10 nylon washer 1 ½" BSPP plug 1 ½" Dowty sealing washer ¼" BSPP plug			Drive to gearbox connection Drive to gearbox connection Drive to gearbox connection Front cover to pump case Front cover to pump case Front cover to pump case Inspection cover to front cover Drain plug Drain plug to casing sealing Front cover lube level
VF100 Close coupled mounting frame assembly				
32	Mounting frame left Mounting frame right VF100 Cross members	129.1322		
	Fastener kit	129.0908.1P		

VF125 Spare Parts List



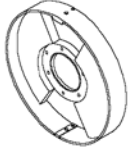
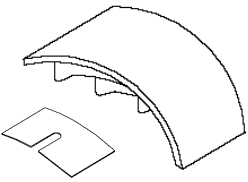
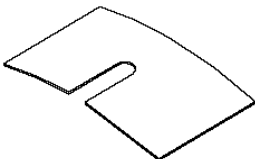

2 Table 2 contains a list of spares to help maintain and repair the VF125 peristaltic pump.

TABLE 2 VF125 SPARE PARTS LIST

Serial (1)	Item Description (2)	Part No (3)	Qty (3)	Image (4)
1	Front Cover 'O' Ring (1260mm x 8mm)	129.1112	1	
2	Rotor	129.1982	1	
3	Rotor shoe assembly c/w shim pack	129.1363.A	1	
4	Shim pack	129.1934.M	14 Pack	







(continued)

TABLE 2 VF125 SPARE PARTS LIST (continued)

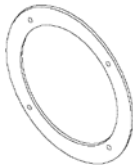
Serial (1)	Item Description (2)	Part No (3)	Qty (3)	Image (4)
5	Front cover (28 hole)	129.1969	1	
6	Hose (NR black)	129.9016	1	
7	Hose (NBR)	129.9021	1	
8	Hose (EPDM)	129.9020	1	
9	Hose CSM(black)	129.2019	1	
10	Taper lock bush (Type 5040.110) (Type 5040.120)	129.1960 129.1963	1	No Image

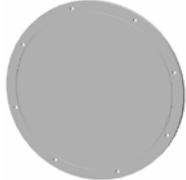
(continued)

TABLE 2 VF125 SPARE PARTS LIST (continued)

Serial (1)	Item Description (2)	Part No (3)	Qty (3)	Image (4)
11	Drive Gasket	129.2978	1	
12	Filler tube	129.1261	1	
13	Inspection cover c/w 'O' ring	129.1236	1	
14	Inspection cover 'O' ring	129.1979	1	
Port Flange Sealing Kits 129.1040 Comprising:-				
15	Port flange 'O' ring	129.1040	2	
16	Port flange gasket	129.1040	2	
17	Sealing ring	129.1040	2	

(continued)

TABLE 2 VF125 SPARE PARTS LIST (continued)

Serial (1)	Item Description (2)	Part No (3)	Qty (3)	Image (4)
Port flange assembly SS				
18	Port flange outer half	129.1971	2	
19	Port flange insert half	129.1970.S= SS 129.1970.M = MS	2	
20	Fastener kit (Steel)	129.0909.3P	1	Image required
Port flange assembly (Plastic)				
21	Port flange outer half	129.1971	2	
22	Port flange insert half	129.1970.P = PP 129.1970.V = PVDF	2	
23	Fastener kit (Plastic)	N/A	2	Image required
24	5" BSP female screw on flange (PN16 only)	129.1951	2	Image required

(continued)

TABLE 2 VF125 SPARE PARTS LIST (continued)

Serial (1)	Item Description (2)	Part No (3)	Qty (3)	Usage (4)
VF125 Mounting Frame assembly fastener kit (129.0909.1P)				
25	M24 washer M24X50 bolt M16X50 bolt M16 nylon insert nut M16 washer			Mounting frame to pump case Mounting frame to pump case Cross member to support frame Cross member to support frame Cross member to support frame
VF125 Rotor shoe assembly fastener kit (129.0909.2P)				
26	Split dowel pin M20 washer M20X75 bolt			Rotor shoe fastening Rotor shoe fastening Rotor shoe fastening
VF125 Port flange assembly fastener kit (129.0909.3P)				
27	M8X16 cap head screw M8 washer M8X20 cap dowel pin M16X100 stud M16 washer			Flange to insert connection Flange to insert connection Flange to insert connection Port flange to pump case Port flange to pump case
VF125 Port flange assembly fastener kit - plastic inserts (129.9019.3P)				
28	M16 locknut M8 washer M8X35 cap head screw M16X60 bolt M16 washer			Flange to insert connection Flange to insert connection Flange to insert connection Port flange to pump case Port flange to pump case
VF125 Casing assembly fastener kit (129.0909.4P)				
29	M10X30 bolt M10 full nut M30 eyebolt 'O' ring			Inspection cover Front cover to pump case Front cover lifting Inspection cover
VF125 Close coupled mounting frame assembly				
30	Mounting frame left Mounting frame right Cross members	129.1323		
	Fastener kit	129.0909.1P		

(continued)

INTENTIONALLY LEFT BLANK

VERDER 

VERDER 