



Version 1.0v-05/2021  
Print-No. 01

**Dura 65**

## Dura 65 Spare Parts List

Table 1 contains a list of spares to help maintain and repair the Dura 65 peristaltic pumps. If in doubt, please contact your local Verder distributor with the pump serial number for genuine Verderflex® spares.

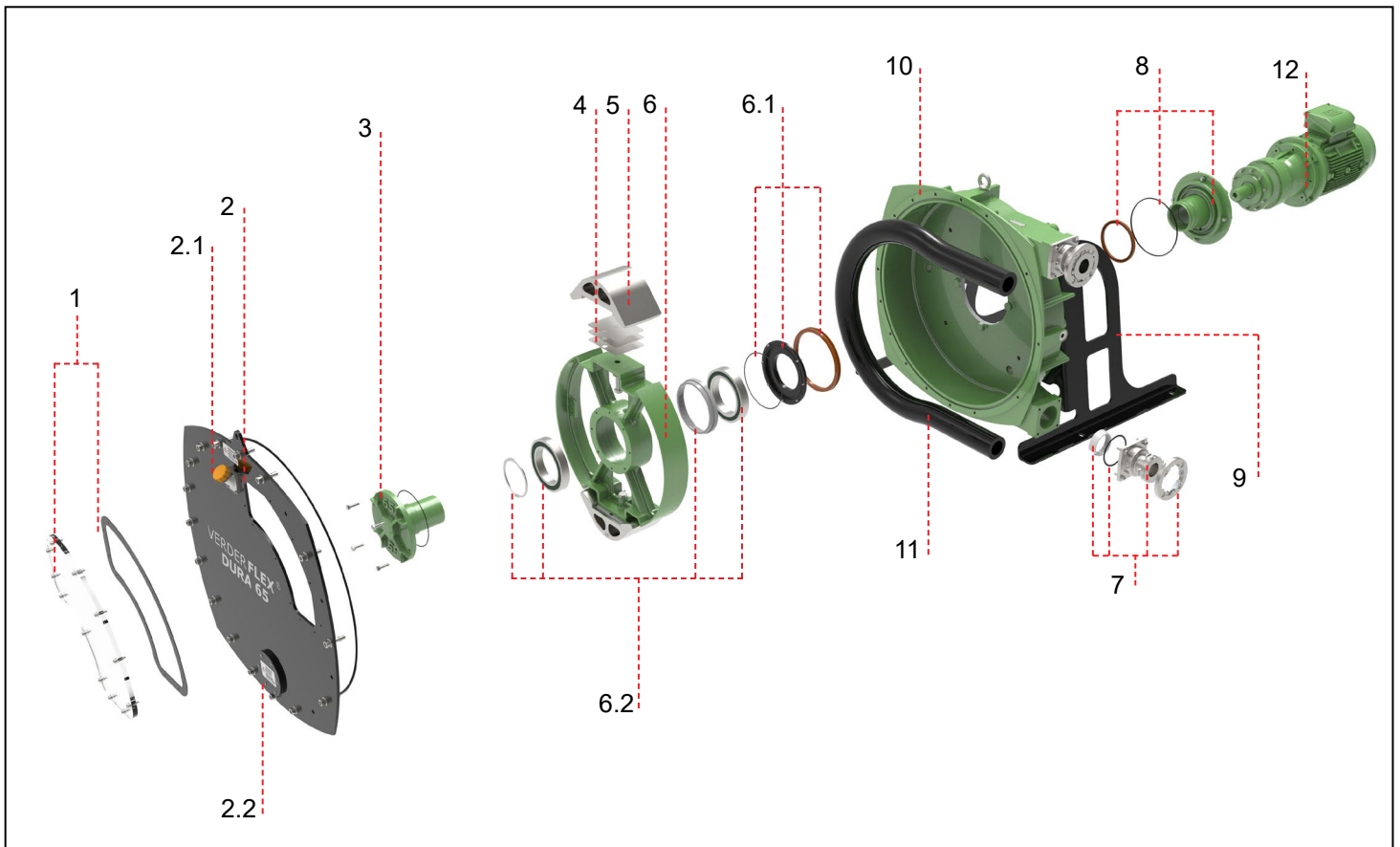

Figure 1 Layout Dura 65 (Generic View)

1	Front Cover Inspection Window and Gasket	4	Shims Pack	8	Gearbox Adaptor/ Bearing Carrier
2	Front Cover Assembly	5	Rotor Shoe Assembly	9	Frames
2.1	Filler Port	6	Rotor Assembly	10	Pump Housing
2.2	Service Cover	6.1	Bearing Seal Kit	11	Hose
3	Drive Coupling and O-Ring	6.2	Bearing Kit	12	Motor
		7	Port Flange Assembly		

**Table 1 Dura 65 Spare Parts List**

Ref	Item	Part No	Qty	Image
1.	Front Cover Inspection Window and Gasket Assembly	149.6501	1	
	ATEX Front Cover Inspection Window and Gasket Assembly*	149.6506	1	
	Inspection Window Gasket	149.6550	1	
2.	Front Cover Assembly	149.6502	1	
	ATEX Front Cover Assembly*	149.6507	1	

\* ATEX spare parts will only be sold to customers who have bought a Factory ATEX rated pump. The pump's serial number is mandatory when ordering ATEX spare parts.



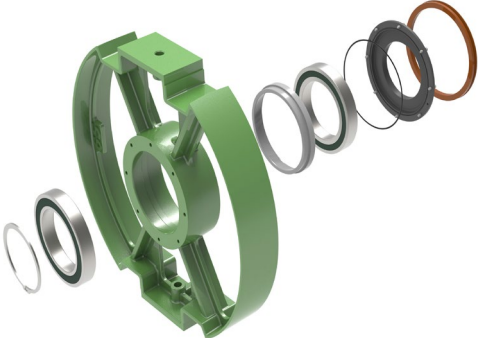
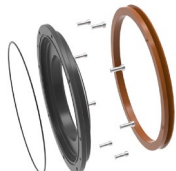

**Table 1 Dura 65 Spare Parts List (continued)**

Ref	Item	Part No	Qty	Image
2.	Front Cover Assembly Pos 4	149.6505	1	
	ATEX Front Cover Assembly Pos 4*	149.6508	1	
	Front Cover O-ring	149.6551	1	
2.1	Filler Port Kit	149.6503	1	
	Filler Port Kit for Pump Fitted with Hose Burst and Vent Kit**	149.6541	1	
2.2	Service Cover Kit	149.6504	1	

\* ATEX spare parts will only be sold to customers who have bought a Factory ATEX rated pump. The pump's serial number is mandatory when ordering ATEX spare parts.

\*\* Filler Assembly for Dura 65 pump fitted with a Hose Burst and Vent Kit (ATEX or non-ATEX) is required to ensure the pressure switch is triggered when a hose bursts.

**Table 1 Dura 65 Spare Parts List (continued)**

Ref	Item	Part No		Qty	Image
3.	Drive Coupling and O-Ring Set or Kit	303/4/5	149.6528	1	
		306	149.6527		
4.	Shims (pack of 16)	149.6513		1	
5.	Rotor Shoe Set or Kit	149.6514		1	
6.*	Rotor Assembly	149.6512		1	
6.1	Bearing Seal Kit	149.6510		1	
6.2	Bearing Kit	149.6511		1	
6.3	Seal Kit	149.6509		1	





\* Rotor Removal Jig available upon request.

**Table 1 Dura 65 Spare Parts List (continued)**

Ref	Item	Part No	Qty		
7.*	Standard Flange <i>(supplied in pairs)</i>	SS 1pc. Solid	149.6516	1	
		SS Flange Without Insert	149.6517	1	
		SS Flange Complete with PP Insert	149.6518	1	
		SS Flange Complete with PVDF Insert	149.6519	1	
		SS Flange Complete with SS Insert	149.6520	1	
7.1	Flange Insert <i>(supplied in pairs)</i>	PP	149.6536	1	
		PVDF	149.6537		
		SS	149.6538		



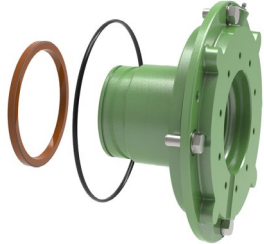

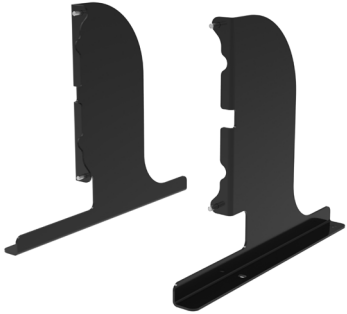
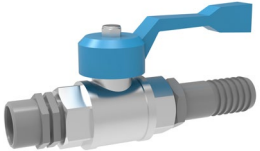





\*For temperature limits, please check the datasheet.

**Table 1 Dura 65 Spare Parts List (continued)**



Ref	Item	Part No		Qty	Image
7.2	Hygienic Flange DIN11851 <i>(supplied in pairs)</i>	149.6539		1	
7.3	Hygienic Flange DIN32676 <i>(supplied in pairs)</i>	149.6540		1	
7.4	Clamp Ring <i>(Supplied as Flange Sealing Kit)</i>	149.6515		1	
8.	Gearbox Adaptor/ Bearing Carrier	303/4/5	149.6523	1	
		306	149.6524		
9.	Mounting Frame Assembly	149.6521		1	
		149.6522			
	Drain Assembly	149.6532		1	



**Table 2 Dura 65 Parts for reference (not supplied as individual spares by Verderflex )**

Item		Description	Image
Mounting Frame Fasteners		SCREW HEX HEAD M16 x 50 - 10.9 BZP	
Rotor Shoe Fasteners		SCREW HEX HEAD M20 x 90 - 10.9 BZP	
GMU Adaptor		SCREW HEX HEAD SET M16 x 40 - 10.9 BZP	
Front Cover Screws		SCREW HEX HEAD SET M16 X 50 - 12.9 BZP	
Port Flange Screws		SCREW SOCKET HEAD CAP M12 x 40 - 12.9 BZP	
Inspection Window Screws		SCREW SOCKET HEAD CAP M8 x 30-8.8	
Drive Coupling Screw		SCREW HEX HD SET M10 x 40 - 10.9 BZP	
GMU Screws (306)		SCREW HEX HD SET M14 x 45 - 12.9 BZP	
GMU Screws (303/4/5)		SCREW HEX HD SET M12 x 45 - 10.9 BZP	
Washers	Mounting Frame	M16 flat washer	
	Inspection Window	M8 flat washer	
	Front Cover	M16 flat washer	
	Rotor Shoe	M20 disk lock washer	
	GMU Adaptor Drive Coupling	M16 flat washer washer spring – ø10	
	GMU	Washer Spring Ø14, Steel BZP (306) Washer Spring Ø12, Steel BZP (303/4 &5)	

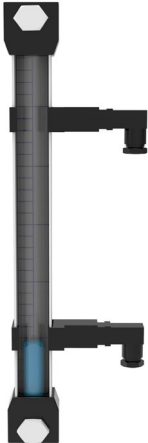
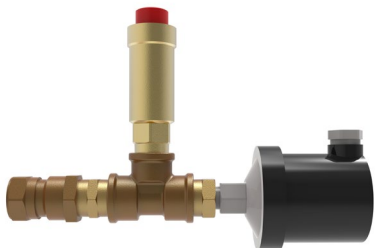
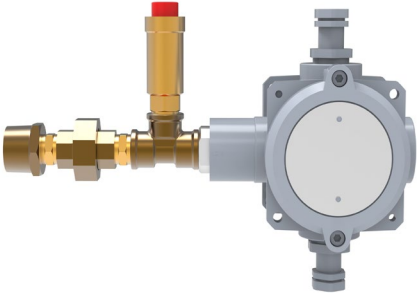
**Table 3 Dura 65 Accessories**

Item	Part No	Qty	Image
High /Low Level Sensor	149.6533	1	
Hose burst kit (Non-Atex)	129.0720	1	
Hose burst kit (Atex)*	149.0730	1	
Revolution sensor	149.6549	1	

\* ATEX spare parts will only be sold to customers who have bought a Factory ATEX rated pump. The pump's serial number is mandatory when ordering ATEX spare parts.

**Table 4 Dura 65 Hose Options**

Item		Part No	Qty	Image
Hose option <i>NR/White</i>	singles	129.0007	1	
Hose option <i>NBR/Yellow</i>	singles	129.0518	1	
Hose option <i>NBRF/Yellow + White</i>	singles	129.2027	1	
Hose option <i>Hypalon® / Green</i>	singles	129.2016	1	
Hose option <i>EPDM/Red</i>	singles	129.0016	1	

## Table 5 Dura 65 Pump Lubricants

The pump must always be filled with the correct amount of lubricant to the middle level marks of the front cover. Table 5 shows the standard amount of lubricant supplied with Dura pumps in litres and US gallons.

Pump Size	Lubricant	Standard Quantity Supplied with Pump in Litre (US Gallons)	Part No
Dura 65*	Verderlube®	15 Litres (4.75 US Gallons)/bottle	129.1417
	VerderSil®	15 Litres (4.75 US Gallons)/bottle	129.1378

\* The quantity of lubricant required for Dura 65 is 25 Litres (6.6 US Gallons).

## Trademarks

VERDERFLEX® is a registered trademark of Verder International B.V. No permission is granted to use any Verder, trademarks or trade names included in this document without the prior written agreement of Verder International B.V.

Tri-clamp® is a registered trademark of Alfa Laval Corporate AB.

Hypalon® is a registered trademark of RSCC Wire & Cable LLC.