

## VPCP **VEGETABLE & POTATO PUMPS**

Up to 50% less damage to your product



### **Benefits of the Packo VPCP pump**

- *Cleaner & more resistant*
- *Save money: lower product damage*
- *Shortest downtimes - heavy construction*

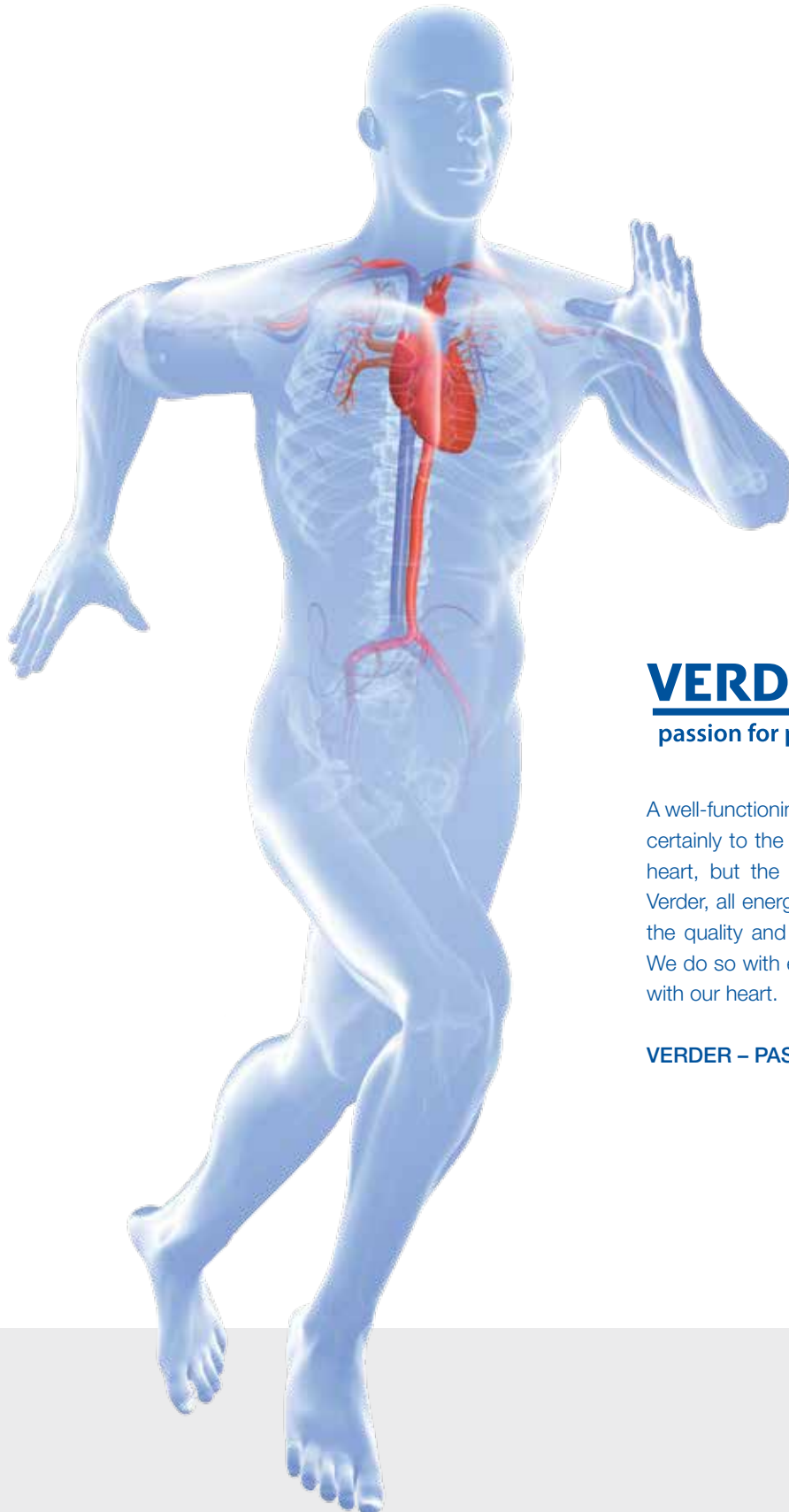

**VERDER**  
passion for pumps

A well-functioning pump helps you succeed. That applies certainly to the most important pump in life, the human heart, but the same goes for pumps in business. At Verder, all energy and attention is focused on improving the quality and performance of our pump and service. We do so with energy, dedication and most importantly, with our heart.

**VERDER – PASSION FOR PUMPS**





# Packo VPCP vegetable pump series

The gentle vegetable pump

## Advantages of the Packo VPCP pumps

- ↳ Gentle, low shear pumping action up to 50% less damage to the product
- ↳ Single vane rotor ideal for fragile and sensitive vegetables
- ↳ Larger pump casing and larger free passage for damage free pumping
- ↳ Longer life of the seal: single mechanical seal without oil bath
- ↳ Better cleanability through electropolish method

Standard IEC normalized motor, flexibility in options - standardization for customers.

Compact monobloc construction, dimensionally shorter than the VDKM pump series. Same built-in dimensions as the VDKM pumps, easily interchangeable.

Sledge construction by which the pump can be easily slid backwards while the pump casing remains in the piping system: short downtimes.

Pump construction in electropolished stainless steel AISI 304.

- increased corrosion resistance.
- better cleanability.
- visually more attractive.

Easy cleanable base plate.

Duplex stub shaft allows a quick and easy disassembly of the vane.

Especially designed vane with large passage. One of the largest free passages in product pumps on the market. Together with the shape of the volute the ideal solution to pump without product damage.

Available with vertical or horizontal outlet.

Pump is equipped with large inspection trap cover and drain.

The VPCP Pump Series comes with only two standardized (EN 12756) mechanical seal diameters (3 to 45 kW and from 5 to 10 inch).

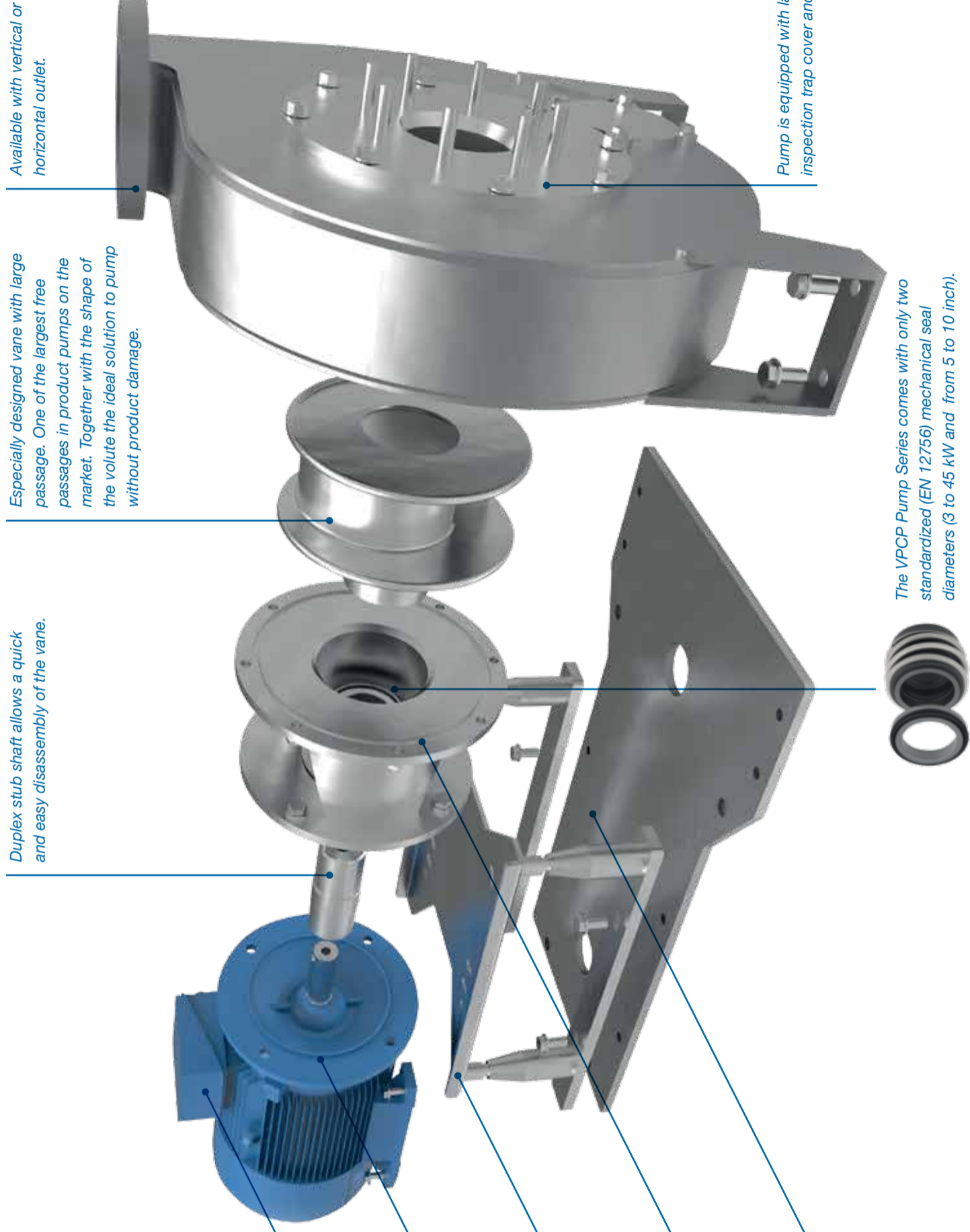



VPCP/125-315

Ø 105mm

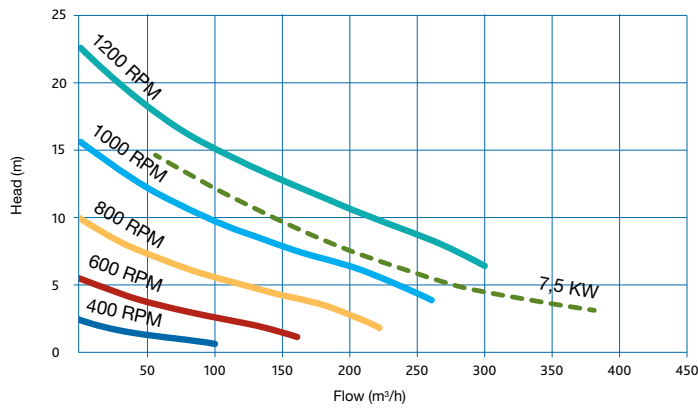

VPCP/200-500

Ø 171mm

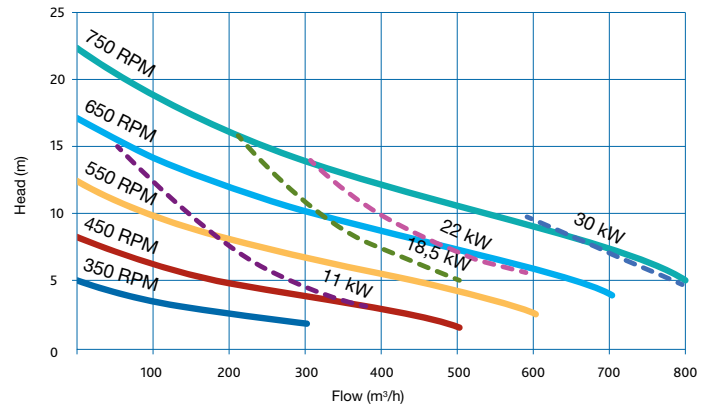

VPCP/150-400

Ø 133mm

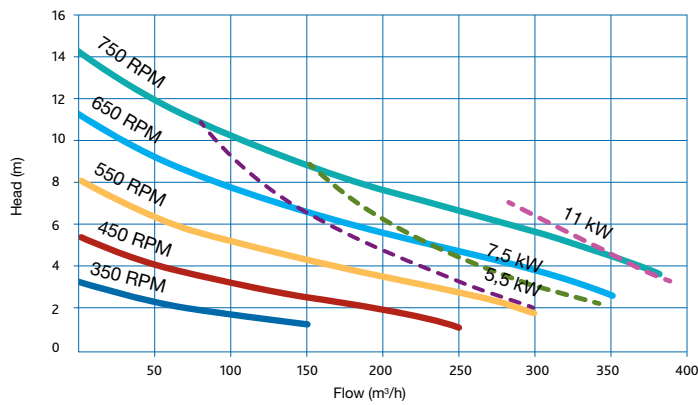

VPCP/250-630

Ø 213mm

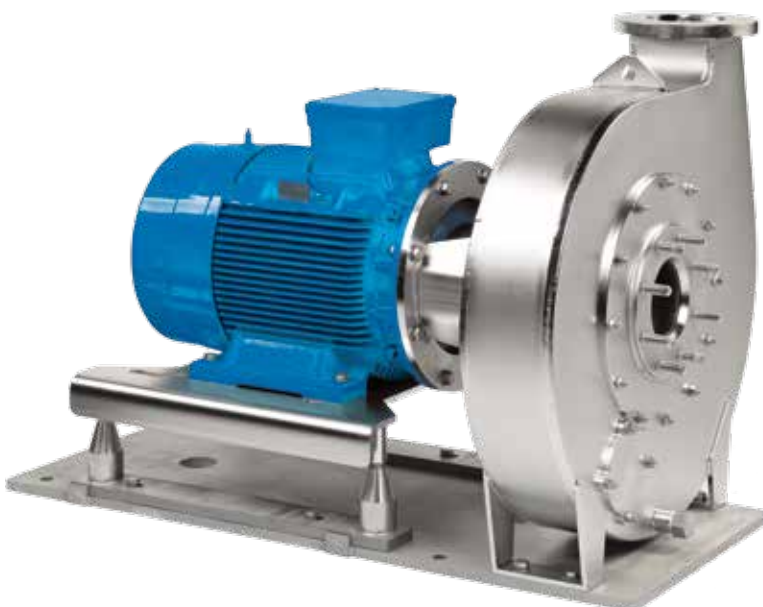
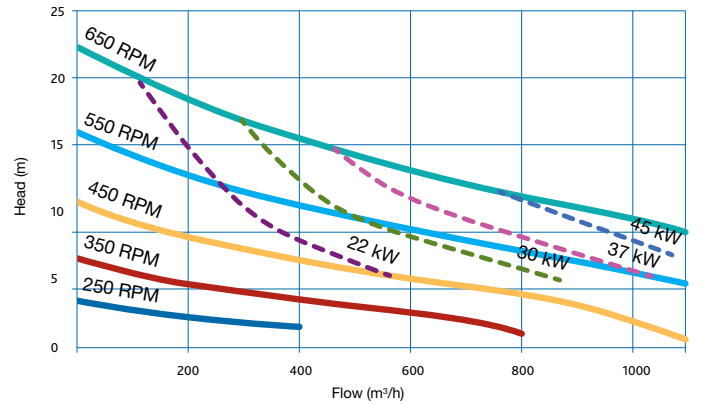

### Calculate your advantage\*

50% less damage to your product

#### Pumping potatoes:

Ton/hour	20
Hours/day	24
Days	320

Total ton/year 153,600

#### Damage/year

3% (4,608 ton) € 691,200\*\*

A VPCP pump lowers damage to 2%



Savings/year

€ 230,400

\* 2% is an example

\*\* Assumed: price potatoes € 150/ton





## Test results prove 50% less damage to the product

Based on percentage and extend of the damage

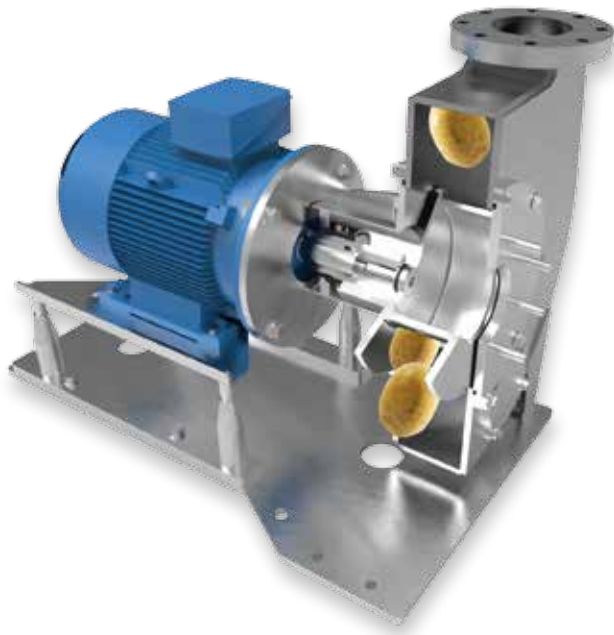

### Conclusion:

No single pump outscores the VPCP pump series in terms of product damage

#### Cleaner & more resistant

- Electropolished
- Construction in SS AISI 304
- Compact construction
- Equipped with large inspection trap and drain

#### Save money: Lower product damage

- Soft and damage free pumping
- Specially designed vane and large pump casing
- Extremely large passage
- Steeper pump curve: easier to adjust
- Pressure loss calculation available

#### Shortest downtimes

- Mono bloc design with motor sledge
- Standard IEC motors
- Longer seal life: heavy construction
- Easy, modular and maintenance friendly design
- Stub shaft for quick and easy disassembly

#### VERDER LIQUIDS BV

Utrechtseweg 4A  
3451 GG Vleuten  
The Netherlands

MAIL [info@verder.com](mailto:info@verder.com)  
WEB [www.verderliquids.com](http://www.verderliquids.com)

AUSTRIA / BELGIUM / BULGARIA / CHINA / CROATIA / CZECH REPUBLIC  
DENMARK / FRANCE / GERMANY / HUNGARY / INDIA / ITALY / JAPAN / THE  
NETHERLANDS / POLAND / ROMANIA / SERBIA / SLOVAKIA / SLOVENIA  
SOUTH AFRICA / SWITZERLAND / THAILAND / UNITED KINGDOM / USA